

USAF Southeast Asia Monograph Series  
Volume III  
Monographs 4 and 5

# The Vietnamese Air Force, 1951–1975

An Analysis of Its Role in Combat

and

# Fourteen Hours at Koh Tang

Major A.J.C. Lavalley  
General Editor

New Imprint by  
OFFICE OF AIR FORCE HISTORY  
UNITED STATES AIR FORCE  
WASHINGTON, D.C., 1985

**Library of Congress Cataloging-in-Publication Data**

**Momyer, William W.**

**The Vietnamese Air Force, 1951-1975.**

(USAF Southeast Asia monograph series ; v. 3, monographs 4 and 5)

First work by William W. Momyer; 2nd work prepared for Louis L. Wilson, Jr., by Thomas D. Des Brisay.

Reprint. Originally published: Air University, 1976.

Includes index.

1. Vietnamese Conflict, 1961-1975—Aerial operations, Vietnamese. 2. Aeronautics, Military—Vietnam—History. 3. Vietnam. Không-quân—History. 4. Mayaguez Crisis, May 1975. I. Des. Brisay, Thomas D. Fourteen hours at Koh Tang. 1986. II. Title. III. Title: Fourteen hours at Koh Tang. IV. Series: USAF Southeast Asia monograph series ; v. 3, monograph 4-5. DS558.8.M65 1986 979.704'348 85-18894 ISBN 0-912799-28-5

This volume is a reprint of a 1976 edition originally issued by the Air University.

---

For sale by the Superintendent of Documents, U.S. Government Printing Office  
Washington, D.C., 20402

## Foreword

In our continuing effort to document the use of airpower in Southeast Asia, we present in this volume two major contributions to the "airpower story."

Monograph 4, "The Vietnamese Air Force, 1951-1975, An Analysis of its Role in Combat," was written by General William W. Momyer, USAF (Ret), former commander of air forces in Vietnam. It presents an objective review of the South Vietnamese Air Force (VNAF) and the role played by the U.S. Air Force in VNAF's short 14-year life span. To provide the necessary perspective to this complex subject, the author presents a comparative analysis of the successes and failures of airpower during the three major enemy offensives of 1968, 1972 and 1975.

The conclusions touch upon some of the fundamental doctrinal principles of airpower and highlight areas that must be carefully considered in any future employment.

The events presented in Monograph 5, although not directly related to the war in Vietnam, took place in Southeast Asia, and were performed by the same men, organizations, and machines which fought so gallantly in that war. It is almost a step-by-step account of the "Mayaguez Affair" and the role of airpower in its successful outcome. Particular emphasis is given to the courage and determination of the young helicopter pilots during the delivery and recovery of U.S. Marines from Kho Tang Island.

These two monographs provide the student of airpower with an excellent case study in the tactical employment of air resources at two widely separated points in the spectrum of conflict. For the general reader, they provide a vivid and substantive discussion on the use of combat airpower and should give some understanding of the magnitude and complexity of any airpower operation, large or small.



WILLIAM V. McBRIDE, General, USAF  
Vice Chief of Staff



"...TO ALL WHO SERVED"

**MONOGRAPH 4**

**The Vietnamese Air Force, 1951 – 1975,  
An Analysis of its Role in Combat**

**William W. Momyer**  
General, USAF (Ret)

10 September 1975

Edited by:  
Lt Col Charles McDonald  
Major A.J.C. Lavalle

Illustrated by:  
Major A.J.C. Lavalle



## **Acknowledgements**

Any effort of this magnitude, especially considering the short time allowed, requires the hard work, determination and perseverance of many more people than the author himself. I would like to express my deep appreciation and indebtedness to the following people who contributed directly to the preparation of this study: Mr. Vernon Tise, AF/IN; Major Hugh Mobley and Captain Joe Henderson, AF/LGX; Captain John Vickery, AF/XOO; and Mrs. Margaret Livesay and her staff at the USAF Photo Depository. Additionally, I wish to make special acknowledgement of the services of Mrs. Mary Jane Kelley, my secretary, and Lt Colonel Charles McDonald and Major Jack Lavalley, my right and left hands.

W. W. MOMYER, General, USAF (Ret.)





# Contents

	Page
ABSTRACT . . . . .	xii
I. INTRODUCTION . . . . .	xiv
II. EARLY YEARS—1954—1961 . . . . .	1
III. TRANSITION—1961—1965 . . . . .	4
A. Wars of Liberation . . . . .	4
B. Corps Commanders and Commands . . . . .	4
C. Tactical Air Control System (TACS) Emerges . . . . .	8
D. Development of the Air-Ground Operations System . . . . .	8
E. Forward Air Controllers (FACs) . . . . .	11
IV. EVE OF THE 1968 TET OFFENSIVE . . . . .	16
A. Enemy Ground Forces . . . . .	17
B. Anti-Aircraft Defenses . . . . .	17
C. Friendly Ground Forces . . . . .	18
D. Friendly Air Forces . . . . .	19
E. Tactical Airlift . . . . .	22
F. Command and Control . . . . .	24
G. Summary—Eve of Tet . . . . .	26
V. TET OFFENSIVE—1968 . . . . .	29
A. Response at Khe Sanh . . . . .	30
B. Quang Tri and Hue . . . . .	30
C. Saigon—Bien Hoa . . . . .	31
D. II, III and IV Corps . . . . .	33
E. Summary . . . . .	33
VI. EVE OF 1972 EASTER OFFENSIVE . . . . .	36
A. Enemy Ground Forces . . . . .	40
B. Anti-Aircraft and SAM Defenses . . . . .	41
C. Friendly Ground Forces . . . . .	41
D. Friendly Air Forces . . . . .	41
E. Enemy Air Force . . . . .	42
F. Airlift . . . . .	43
G. Command and Control . . . . .	43
VII. INVASION IS LAUNCHED—MARCH 30, 1972 . . . . .	45
A. Quang Tri . . . . .	45
B. Kontum—Pleiku . . . . .	46

	C. An Loc .....	47
	D. U.S. Response .....	50
	E. Summary .....	51
VIII.	CONSIDERATIONS IN THE CEASE FIRE, JANUARY 27, 1973 .....	53
IX.	WAR CONTINUED AND STRATEGY UNDER REVIEW .....	57
	A. Cooper-Church Amendment August 1973 .....	57
	B. North Vietnam's Response .....	57
	C. South Vietnam's Response .....	58
X.	VNAF ON THE EVE OF THE MARCH 1975 OFFENSIVE .....	60
	A. Expansion .....	60
	B. Maintenance and Supply .....	61
	C. Operations .....	62
	D. Intelligence .....	67
	E. Command and Control .....	68
IX.	GROUND SITUATION, FEBRUARY 1975 .....	70
XII.	NORTH VIETNAMESE OFFENSIVE OF 1975 .....	73
	A. Ban Me Thuot .....	73
	B. Realignment of Forces in MR I .....	73
	C. Cam Ranh Bay Meeting 14 March .....	74
	D. Retreat from Pleiku-Kontum .....	74
	E. Danang Falls .....	75
	F. Coastal Cities Fall .....	77
	G. Change in Control of Sorties .....	78
	H. Xuan Loc .....	78
	I. Morale .....	80
XIII.	SUMMARY .....	81
XIV.	CONCLUSIONS .....	82

# SOUTH VIETNAM

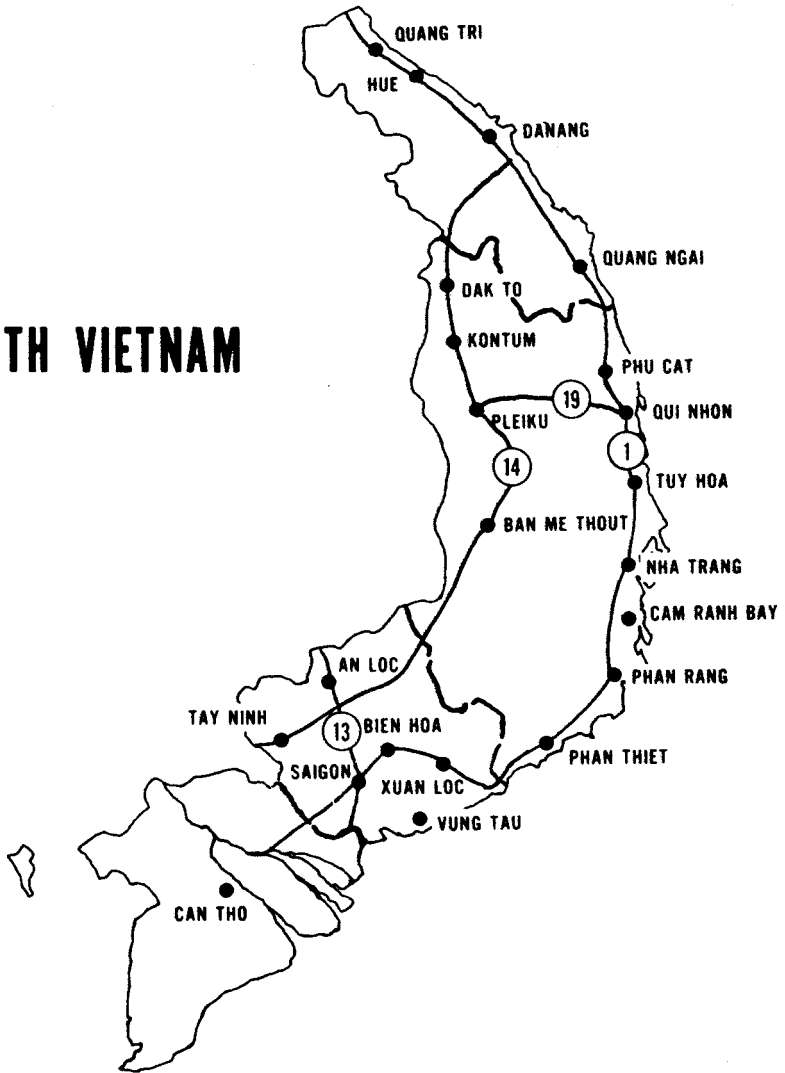

Major towns & highways in South Vietnam

## Abstract

As the final days of Vietnam unfolded, the question was raised, "What happened to the Vietnamese Air Force (VNAF)?" This monograph addresses that question in considerable detail. In order to sift out the story, three periods in the life of VNAF were selected—the Tet offensive of 1968, the Easter offensive of 1972, and lastly the March offensive of 1975. By examining each of these time periods, the factors at work in each period could be isolated so as to determine the performance of the VNAF.

The role of the USAF was dominant in the 1968 and 1972 offensives. Although VNAF had grown in size to about 44 squadrons and 42,000 people by the time of the 1972 offensive, application of airpower at the major points of the enemy assault was U.S. Further, the bombing of the North Vietnam heartland during these two periods was the compelling leverage that resulted in the initiation and pursuit of active negotiations to stop the war.

The intervening period between the peace agreement of January 27, 1973 and the North Vietnamese offensive of March 1975, was marked by fundamental changes in the character of the NVA forces and their deployment for battle. The NVA moved its center of logistics near the DMZ and into South Vietnam proper. The magnitude of SAM and AAA defenses constituted a major departure from those of the 1968 and 1972 campaigns. The VNAF, structured for a low scale war, was confronted with an enemy having the most sophisticated air defense weapons of the day.

The Cooper-Church Amendment had a profound effect on the morale and outlook of South Vietnamese leaders at all levels. No longer was there a lever to deter the North Vietnamese from building up forces for an all-out fight for a military victory. Only the threat of resuming the bombing restrained North Vietnam. With the amendment, this threat was neutralized. Finally, whereas U.S. airpower had been decisive in halting the 1968 and 1972 offensives, that firepower would no longer be available. Confronted with these factors and the curtailment of money and equipment, Vietnamese leadership stood at the crossroads on the brink of the 1975 offensive.

VNAF throughout its short history was never given the stature and equality of command relationship essential to success in battle where air and ground forces must work as partners. In 1975, the division of VNAF into separate packages and assigning them to the command of Corps/MR commanders negated the demonstrated potential of airpower to support an army under stress. Whether VNAF could have slowed the enemy advance until a new de-

fense line could be established is questionable under the circumstances, but the parcelling out of VNAF to the Corps/MR commanders assured the inability of VNAF to do such a job.

From the analysis of the three campaigns the following general conclusions emerge:

A. The lack of centralized control of VNAF fragmented the employment of the force. Thus, VNAF was not used where and when it should have been to have had the most effect on the ability of the NVA to fight.

B. VNAF was designed to fight in the permissive environment of the 1968 campaign. By 1975 the enemy had produced an environment calling for the sophisticated Air Force that fought over the heartland of North Vietnam.

C. Interdiction limited the capacity of the NVA to maintain a decisive military capability in the 1968 and 1972 campaigns. With the cessation of the bombing of North Vietnam, there were no restraints on the build-up of NVA forces and logistics. As a result, they could sustain a campaign of indefinite duration in 1975.

D. There was no overall integrated planning for the conduct of the war. The Joint General Staff was not empowered to do the necessary planning for the employment of all four military regions and VNAF. Further, the JGS did not have a balanced representation of airmen throughout the staff to assure proper planning for the employment of VNAF forces.

E. Interdiction limited the capacity of the NVA to maintain a decisive military capability in the 1968 and 1972 campaigns. With the cessation of the bombing of North Vietnam, there were no restraints on the build-up of NVA forces and logistics. As a result, they could sustain a campaign of indefinite duration in 1975.

## **I. Introduction**

This paper was prompted by the question, "What happened to the VNAF (Vietnamese Air Force) in the March 1975 offensive of the North Vietnamese?" In order to gain an understanding of the development, capability and employment of VNAF, three different campaigns were selected which would provide a backdrop for looking at the question. These campaigns selected were the Tet offensive of 1968, the North Vietnamese offensive of Easter 1972, and lastly the current March 1975 offensive. By analysis of these operations there should emerge a picture of the development of VNAF and its performance.

## II. Early Years—1954—1961

The VNAF was formed in 1951 as a part of the French Air Force in Indo-China. The French made little effort to develop the VNAF into a self-sufficient Air Force. Vietnamese pilots were viewed as fillers in French squadrons and it wasn't until 1954 that the beginning of a Vietnamese Squadron can be identified.

With the fall of Dien Bien Phu in May of 1954, VNAF consisted of 58 aircraft and approximately 1,345 people. In no sense of the word could one call it an Air Force. The French made no significant effort to expand and develop the VNAF to assume a significant role in operations below the 17th parallel. By 1957, the United States had taken over the Military Assistance Program. Up until this time, money appropriated for the development of the Vietnamese armed forces was funneled through the French, and the French carried out the training of the Vietnamese. There was considerable discontent with this procedure and by 1957 the U.S. assumed de facto responsibility for the training of Vietnamese forces and in essence set the stage for the transition of assistance to eventual covert and overt participation in the struggle to maintain the integrity of South Vietnam.

The expansion of the VNAF took on the semblance of a small Air Force in this time period. It is of note that the enemy activities in South Vietnam were considered more of an insurgency or a sophisticated form of guerrilla warfare, highly organized and directed throughout the country. On the other hand the French went down to defeat in North Vietnam not as a result of a guerrilla war, but from a highly stylized army that used a mass of artillery to prepare the battlefield prior to the assault by infantry troops organized into formal formations and supported by modern arms. Thus, in hindsight it seems an anomaly that the war in South Vietnam should be perceived as an insurgency while the war in North Vietnam had the characteristics of some elements of World War II and Korea where highly articulated forces were required to assault a bastion of defense such as the French had developed at Dien Bien Phu. This distinction in the perception of the war in South Vietnam had a major bearing on the shaping and control of VNAF. It would be many years later that these initial concepts would be discarded, only to find their way back during the last days of life of the VNAF. The VNAF was to be developed to deliver limited firepower in support of troops and to perform a relatively low level of photographic reconnaissance. Since the enemy operated with small forces, was highly mobile, and received substantial support from the local population,

Regional and Popular forces were the backbone for resisting and eliminating these Viet Cong guerrilla units. ARVN (Army of Vietnam) was designed and developed to take over the fight from RF and PF forces when significant numbers of guerrilla forces were concentrated against District and Province capitals.

These early years in the life of VNAF are reflected in the activation of one squadron of F-8 fighters, two squadrons of C-47s and two squadrons of L-19s. As can be seen, the emphasis was not on the delivery of firepower, but on visual observation with L-19s and limited movement of small bodies of troops, primarily platoons, by C-47s. At this point there was no formalized structure for coordination of ARVN and VNAF activities nor was there a central system for directing the force. With such a small force, there was no need for a central system that was to make its appearance at a later date.

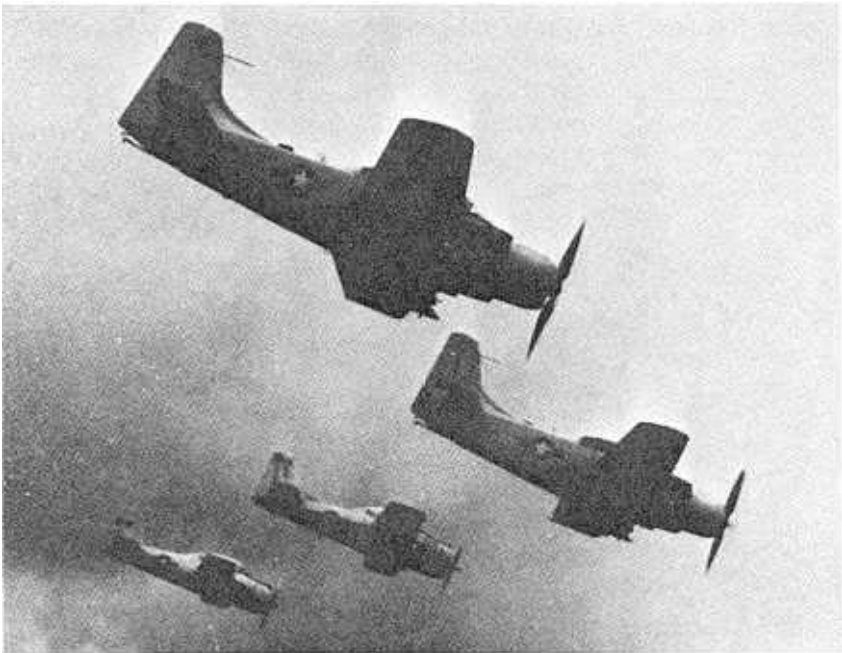

The old and not-so-old VNAF T-28's and replacement A1-E's flying formation, August 1964





A VNAF Sikorsky H-34 at Tan Son Nhut Air Base, RVN

### **III. Transition—1961—1965**

#### **A. Wars of Liberation**

While the war in Vietnam was continually expanding in terms of more widespread assaults across the country, there were major developments in United States Armed Forces as a result of Khrushchev's statement that wars of the future will be wars of liberation. In response to these statements by Soviet and North Vietnamese leaders, President Kennedy directed the development of forces, equipment and tactics to cope with this form of warfare. The result of this directive was the establishment of special forces by the Army and Air Force to undertake this less sophisticated form of warfare. The Army came forth with its special forces and the Air Force activated the 4400th CCTS (Combat Crew Training Squadron) at Eglin Field to train special air warfare forces for counter-insurgency. From the 4400th CCTS came the first organized USAF unit for counter-insurgency—Jungle Jim.

There followed a series of tests in the U.S. involving Army and Air Force units for counter-insurgency. These tests brought into focus the doctrinal differences between the U.S. Army and Air Force on the command and control and employment of air units in a combat theater regardless of the classification of the war. The Air Force contended, and demonstrated in tests, that its concepts developed in World War II and Korea of assigning all air units in a theater of operation to the Air Component Commander and employing those units according to the directives of the theater commander was the most effective way to employ airpower. To achieve this, it was necessary to centralize control but decentralize execution. The tactical air control system provided the tool by which the Tactical Air Force Commander carried out the mission.

#### **B. Corps Commanders and Command**

With the deployment of U.S. Army helicopter forces, the question of command and control was joined. Army stated it should be responsible for command of all air units engaged since it was the responsible Service for counter-insurgency, arguing that counter-insurgency was primarily a ground force operation. Thus, all deployed USAF forces, along with Army forces, should be placed under the operational control of the Senior U.S. Army Advisor to the ARVN Corps Commander. Likewise it was argued that VNAF units should

be placed under the command and control of the ARVN Corps Commander.

On the other hand, the USAF held that all air units should be centralized under the control of the Senior USAF Air Commander since it was essential that the air support be moved back and forth between Corps areas as the level of combat demanded. There simply weren't enough units, both U.S. and Vietnamese, to assign them to control of the Corps Commanders and the U.S. Army advisors to those Corps Commanders. Assigning units in such a fashion would negate using the firepower to best advantage since there would be times where nothing was going on in one Corps and in an adjacent Corps there would be inadequate air effort to support the intensified ground combat.

These differences had an impact as would be expected upon the VNAF and ARVN. VNAF believed that it should not be divided up and placed under the control of each of the ARVN Corps Commanders. There were four Corps with I Corps covering the northern part of the country, II Corps the central highlands, III Corps the area surrounding Saigon and IV Corps the southern delta. ARVN argued that the Corps Commander was both a military and civilian official and as such he was responsible for all activities within that region. Any VNAF units based or used in support of his military or civilian responsibilities should come under his command.

As the level of combat increased, decisions were made to deploy more U.S. Army and Air Force units. A detachment of Jungle Jim consisting of T-28s and B-26s was deployed to train the VNAF and to undertake missions that the VNAF was incapable of performing. These aircraft, initially based at Bien Hoa, were to be used where necessary to cope with an enemy assault. As a consequence of this decision, the argument about command of air units abated

**U.S./GVN COMMAND STRUCTURE (PRE-U.S. WITHDRAWAL)**

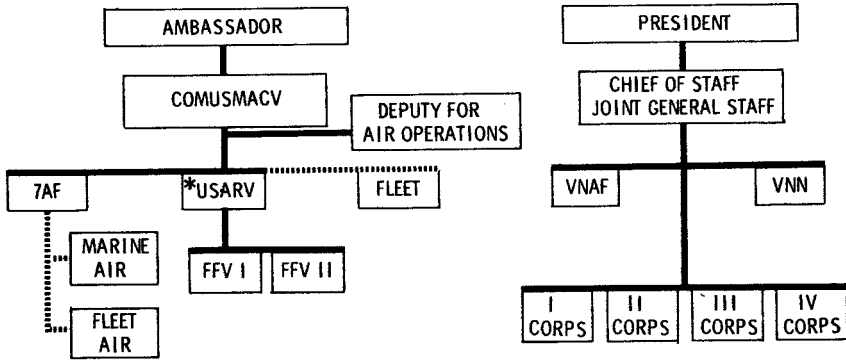

\* LOGISTICAL AND SUPPORT ONLY. COMUSMACV EXERCISED OPERATIONAL CONTROL OF FIELD FORCES.



Two VNAF T-28's patrolling the South Vietnamese coastline



U.S. Air Force B-26 "Invader" supporting Vietnamese ground operation

and the USAF and VNAF came under the command and control of the respective Senior Air Commanders, the 2nd Air Division in the case of USAF units and the VNAF under the Commanding General of the Vietnamese Air Force.

### **C. Tactical Air Control System (TACS) Emerges.**

With the deployment of special air warfare units (Farm Gate), there was a need to bring in a control system to manage the air effort and to regulate the flow of aircraft into the operational areas. There was initial opposition to the deployment of the TACS since it meant the centralized control of air which would not permit the Corps Commanders to have the final say on how the air effort would be used in their areas. The arguments in favor of a control system were overwhelming because of the operational flexibility it would provide. The decision was favorable for deployment, and the USAF would train the VNAF to operate the system. Although VNAF was nominally responsible for the system, the USAF in fact operated the TACS from the outset.

In 1961 the first elements of the TACS deployed. Initially a CRC (Control and Reporting Center), the main block of the system with the heaviest radars, was installed at Tan Son Nhut. A CRP (Control and Reporting Post) was located at Danang and another at Pleiku. By the end of 1962, for the first time, the skeleton of a control system was in place that would permit the Commander of USAF/VNAF at Tan Son Nhut to control and manage air operations to meet the steadily increasing demands of ARVN and U.S. special forces for air support. The creation of a TACC (Tactical Air Control Center) was to follow at a later date, but an AOC (Air Operations Center) functioned in essence as a TACC.

The basic control system was later filled out with the deployment of U.S. combat units and followed in principle those procedures, techniques and tactics developed over the years in war and peacetime. The TACS came to be the real backbone of the high degree of flexibility that was necessary to meet the major offensives in 1968 and in 1972.

### **D. Development of the Air-Ground Operations System**

Whereas the TACS is concerned with the physical control of aircraft and seeing that the aircraft carry out the assigned mission, the air-ground operations system is the heart of the decision process in determining what air will strike, when it will strike and where it will strike. The system is the means by which air and ground commanders coordinate the employment of all forms of firepower, including requests for assistance from external sources. It is the air-ground operations system, therefore, that can make or break close air support effectiveness.

Prior to the introduction of U.S. units in 1961, there was a very elementary air-ground operations system between the South Vietnamese Army and Air

Force. One of the most difficult things to develop in a theater of operations is an air-ground operations system because it must be based on mutual respect and confidence between air and ground forces and acceptance that both forces are co-equal, neither under the control of the other. To do the job and do it well, both forces have to be willing to accept the fact that at times, decisions will be made by the overall Commander that are contrary to the desires of one or the other. Over the years there has come to be an acceptance of this between U.S. Army and USAF component commanders in a theater.

In the Vietnamese armed forces, there was no overall commander of combat operations or what can be considered a theater commander. General Cao Van Vien, Chief of the General Staff, came closest to being an overall commander. In some cases, as the Tet offensive in 1968 and in the 1972 offensive, he actually took to the field and assumed overall command of forces for a short period of time. The normal arrangement, however, was to make the Corps Commanders almost autonomous. That is, the Corps Commanders reported directly to the President on all civil matters in their area, and received direction from the President on critical military matters, although the Corps Commanders were technically responsive to the Chief of the General Staff. As was

### THE TACS IN SOUTH VIETNAM

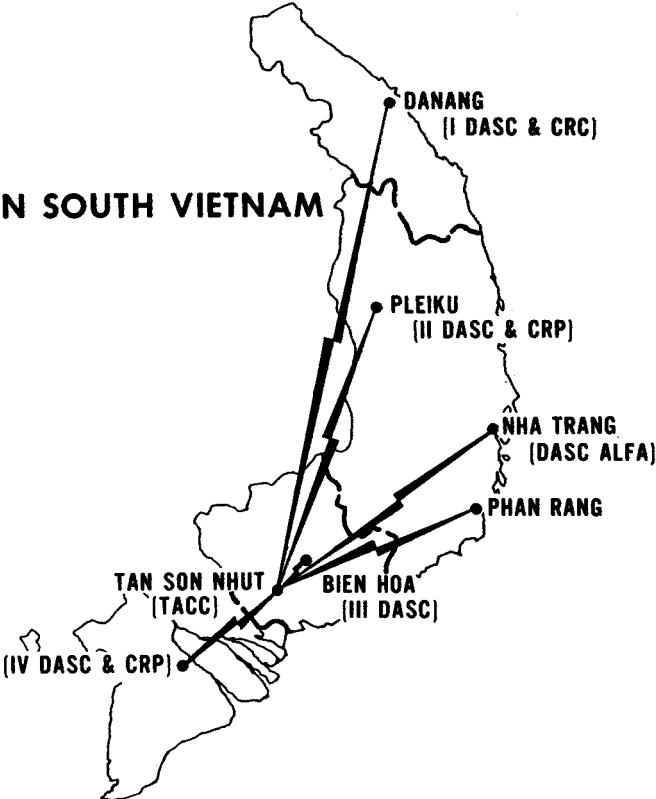

The TACS is essential to the proper employment of airpower within a theater of operations

evident, each Corps Commander had a great deal of authority, and acted almost independently of other Corps Commanders. This arrangement made the Joint General Staff relatively weak and as a result, the JGS couldn't coordinate the activities of the Corps as closely as needed, particularly where the matter of priority for employment of air was an issue.

The air-ground coordination system prior to 1962 consisted of some elements of the French system. The Divisions initiated requests for air support to the Corps TOC (Tactical Operations Center). There was an Air Liaison Officer from VNAF at the TOC. These officers initially were not trained for air support and had little rank which reduced their ability to expertly advise on the use of airpower. The USAF, as it expanded its advisory function, placed experienced ALOs (Air Liaison Officers) in each Corps headquarters with a decided improvement in rapport with ARVN.

When a request for air support was approved by Corps, it was sent to the Joint General Staff in Saigon. The operational element of the Joint General Staff was the Joint Operations Center. There were VNAF and later USAF officers located in the Center. The JOC determined the number of aircraft, armament, time and target for attack. It then passed the approved mission to the AOC (Air Operations Center) which was a VNAF facility with a USAF officer as the deputy director. The AOC then executed the mission with the JOC notifying the Corps of the approved mission. This was the path a pre-planned request followed. If an urgent request developed (an immediate), aircraft were diverted from a pre-planned target.

The system was too slow and there was inadequate air representation throughout the process to make a proper evaluation of the suitability of the mission. As Farm Gate sorties increased, the system needed to be changed to conform with USAF accepted doctrine for the air-ground system. As these changes were discussed, the control of U.S. Army helicopters came up again. It had become clear that much closer coordination was needed for the routing of helicopters, suppression of enemy fire in the target area and diversion to other areas if the situation dictated. The USAF argued that the AOC was the proper agency to exercise this control with senior Army officers assigned to the AOC to advise and assist in the coordination of such activities. Since VNAF was employing helicopters in moving ARVN forces, the problem was common.

Initially, ASOCs (Air Support Operations Centers), later redesignated DASCs (Direct Air Support Centers) were established at each of the Corps headquarters. These ASOCs were manned by VNAF and USAF personnel. For the first time the air-ground operations system began to look like the organization that had been developed over the years for coordinating air-ground operations. The ASOCs were located within a short distance of the Corps TOC. The TOC received a request from a Division and coordinated with the ASOC. The ASOC would then process the request to the AOC, and if the AOC could satisfy it, executed the mission. If it was beyond the capability of the AOC it would go to the JOC for a decision as to which Corps would get the mission. This was a major step forward and became the procedure until the deployment of major U.S. forces in 1964.



The changes made in 1965 made the Air Force responsible for the processing of an immediate request for air support. This was formerly a responsibility of the Army. Both ARVN and U.S. Army retained responsibility for the processing of pre-planned requests. The U.S. Army established a Tactical Air Support Element (TASE) in the Headquarters of 2d Air Division (later designated 7th Air Force). All requests for pre-planned air support for U.S. forces were consolidated by this agency and priorities established. ARVN Corps passed their requests to the Joint Operations Center which placed a priority on the requested mission and then passed the list to TASE. TASE coordinated the final list and priority and passed to the joint USAF-VNAF TACC for execution. This system of handling pre-planned missions was effective and gave ARVN and VNAF co-equal responsibility in the process.

Another change of major importance occurring with the introduction of USAF units was to place about a third of the force on alert to handle immediate requests for troops in contact situations. VNAF during this early period didn't have sufficient forces with the daily commitment for pre-planned missions to hold forces on alert. Diverts were used to handle immediate missions. By virtue of the alerts, the USAF handled a major portion of missions involving troops in contact. In addition, it had been a long process of developing confidence in the ARVN Corps Commander to use air when the situation demanded. There was reluctance to call for air and when it was requested it was not against good targets, in the eyes of airmen. Nevertheless, ARVN commanders preferred not to depend on VNAF air support if they could get USAF strikes. There was no basis for this bias by the time U.S. forces pulled out. VNAF was fully capable of bombing as well as USAF units.

## **E. Forward Air Controllers (FACS)**

The last elements of the air-ground operations system were the Air Liaison Officers and Forward Air Controllers. These elements of the system were in contact with the enemy and, therefore, became the ultimate link in how well airpower was used and the quality of the targets that were requested.

Prior to the deployment of Farm Gate there were no Forward Air Controllers. Since the level of activity was small, this informal arrangement was acceptable since most of the targets were in areas where precise control was not necessary. As the war expanded into populated areas, it became necessary to have precise control of strikes to minimize casualties to civilians. Furthermore, FACS with ARDF (Aircraft Radio Direction Finding) became a primary source of information about the enemy. Flying over designated areas day by day, FACS were able to pick up changes in cultural activities which were indicators of enemy movements and locations. Thus, significant intelligence came from FACS and was a major source of information for targeting strike aircraft.

USAF FACS rapidly expanded during this time period and eventually the point was reached where there were FACS with each U.S. Battalion, Brigade, Division, Special Forces unit and Vietnamese Province. The country was lit-

erally covered by FACs. By June of 1969 there were 61 O-1s, 285 O-2s and 96 OV-10s committed to the support of the FAC program.

The VNAF was strapped to provide trained officers for FAC duty. It was continually faced with a shortage of experienced pilots to man the fighter, reconnaissance and transport squadrons; consequently, the most inexperienced officers just out of flying school were assigned as FACs. This caused not only poor control of strikes, but tended to create a lack of confidence by ARVN in the ability of VNAF to provide close air support as well as the Americans. Although this situation improved later in the war, it was and remained a critical problem. VNAF was not able to provide FACs below Division level because of the shortage of trained people to meet the expansion.



South Vietnamese O-1 "Bird Dog" used for observation and forward air control

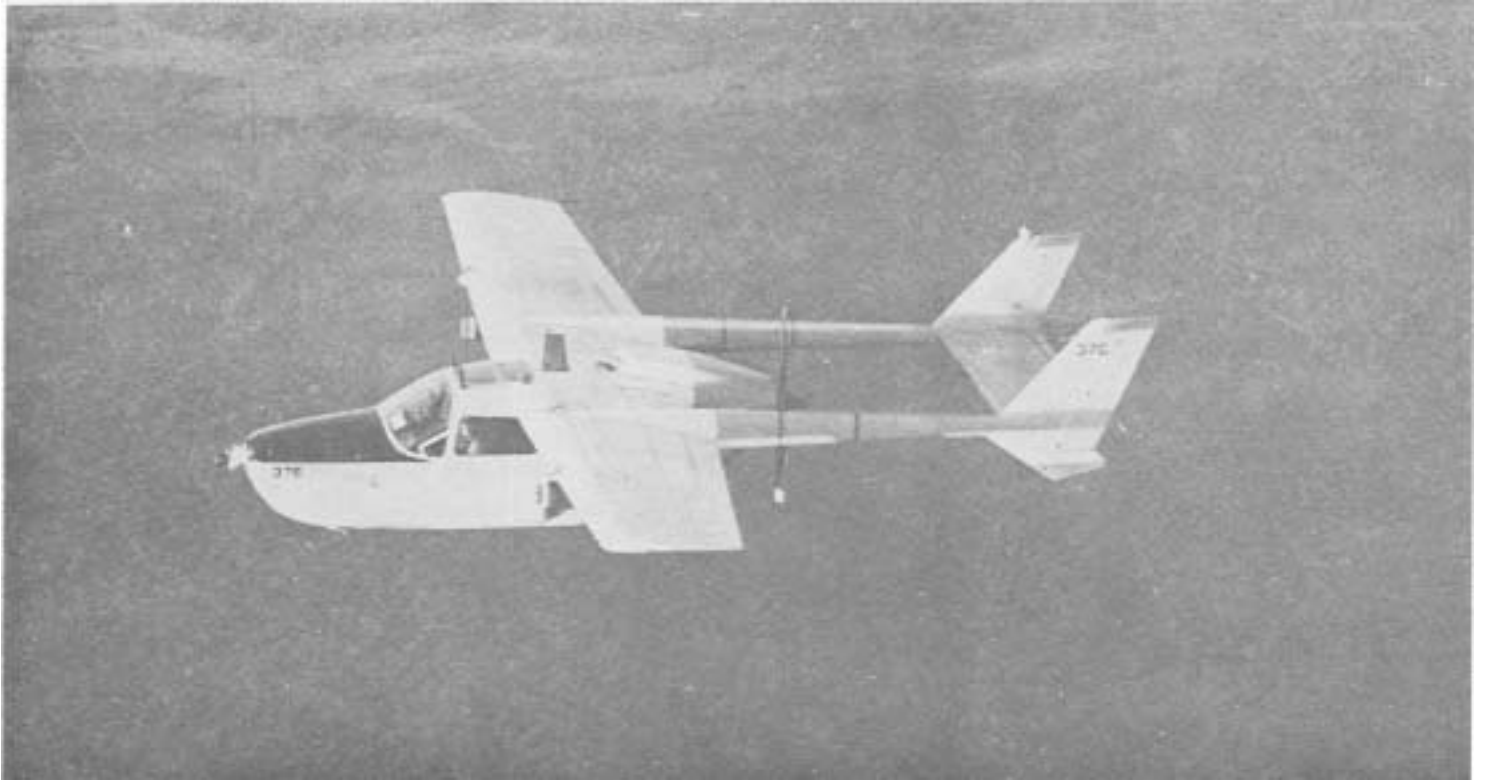

USAF O-2 "Skymaster" replaced the aging O-1 as the primary forward air control aircraft



An OV-10 "Bronco" starting his marking run on a target in the delta region of South Vietnam

## IV. Eve of the 1968 TET Offensive

On the eve of the Tet offensive, U.S. airpower was pounding the heartland of North Vietnam and the lines of communication leading to South Vietnam. Even with restrictions on targets that could be struck in North Vietnam, most of the targets associated with LOCs were blocked. The North Vietnamese Air Force had been driven back into China. The rate of fire of SAMs and AAA had declined significantly. U.S. airpower was capable of eliminating all the remaining targets within North Vietnam if permitted. It was the opinion of most U.S. military leaders that this was the time to go after all the remaining targets. If Hanoi and Haiphong could be brought under attack, the effect of a country-wide air offensive would be so devastating as to force the North Vietnamese to the peace table.

In South Vietnam the enemy had not been able to wage a large scale offensive because of the interdiction campaign and the continued spoiling attacks by U.S. and ARVN ground forces. At best the NVA/Viet Cong could conduct limited attacks and were then compelled to fall back into Cambodia and Laotian sanctuaries to rest, recuperate, restock and prepare for another attack. Under these conditions, there was little chance that the NVA/VC could take and hold any significant area within South Vietnam.

The threat of freeing U.S. airpower for an all-out offensive was the real leverage the U.S. had to bring the war to a halt. By virtue of fighting very limited engagements in order to conserve logistics, the enemy could fight a protracted war. If large scale campaigns were initiated, the effects of U.S. airpower would be decisive since large quantities of logistics and sophisticated arms such as SAMs, heavy artillery, tanks and other supporting equipment would have to be moved into South Vietnam. The inability to prevent U.S. airpower from attacking these weapons and supplies made large scale combat actions risky. When such actions were attempted they could not be sustained to have a significant effect on the fight for control of South Vietnam. Thus, the real leverage possessed by the U.S. at this time was the widespread use of airpower to destroy the North Vietnamese homeland and its ability to support forces in South Vietnam. This leverage existed, regardless of unlimited supplies and equipment furnished by China and the USSR.

From the enemy's point of view, if an offensive was to be waged in South Vietnam, it would have to be of relatively short duration and designed to have a political effect on the U.S. home front which was showing signs of war weariness and discontent within many elements of the country. The size of

## STATUS OF FORCES ON EVE OF "TET" (1968)

### SOUTH VIETNAMESE FORCES

● DIVISIONS	12+
NO. OF PERSONNEL	606,100
● MAIN FORCE ARVN	302,000
● REGIONAL FORCES	152,200
● POPULAR FORCES	151,900
● TANKS	N/A
● AIRCRAFT (VNAF)	362
NO. OF PERSONNEL	16,277
● BOATS (VNN)	287
NO. OF PERSONNEL	16,400

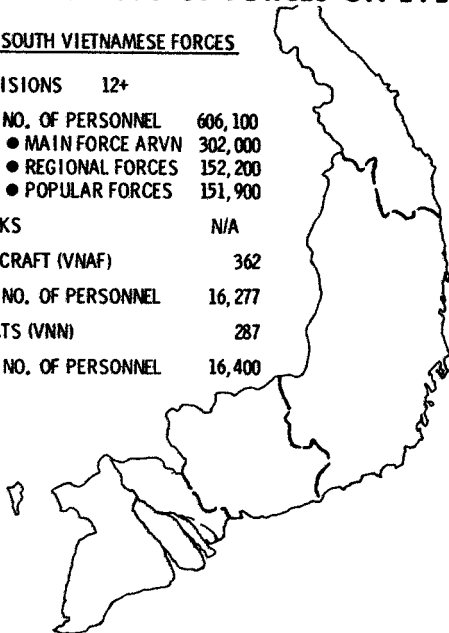

### NORTH VIETNAMESE FORCES (IN SVN)

● DIVISIONS	11+
NO. OF PERSONNEL	224,600
● MAIN FORCE NVA	55,500
● MAIN FORCE VC	59,700
● GUERRILLA	71,700
● ADMINISTRATIVE	37,700
● TANKS	12
● AIRCRAFT	NONE
● AIR DEFENSE UNITS	NUMEROUS 12.7 & Q-50s
● BOATS	NONE

U.S. and ARVN forces, plus overwhelming airpower, made it infeasible to inflict a decisive and major defeat on these forces. At best such an offensive could create uncertainties about the claims of U.S. military leaders that it was only a matter of time until the North Vietnamese would have to give up the fight. Such an offensive, however, would buy time, and time, according to the North Vietnamese, was working for them. From these considerations, it would appear that the primary thrust of the offensive was political, designed to create disension on the U.S. home front and break down support for the war effort.

### **A. Enemy Ground Forces**

The North Vietnamese and Viet Cong had about 200,000 troops dispersed throughout the country. Most of the battles had been relatively small scale and were fought by battalion size units. VC forces were the dominant force and were dispersed throughout all four Corps areas.

### **B. Anti-Aircraft Defense**

There was very limited anti-aircraft fire throughout Vietnam. Most of the weapons were 12.7mm and usually concentrated where there were troops in contact. As a result, almost all types of aircraft could operate without significant interference or losses from AAA fire. The USAF and VNAF losses to

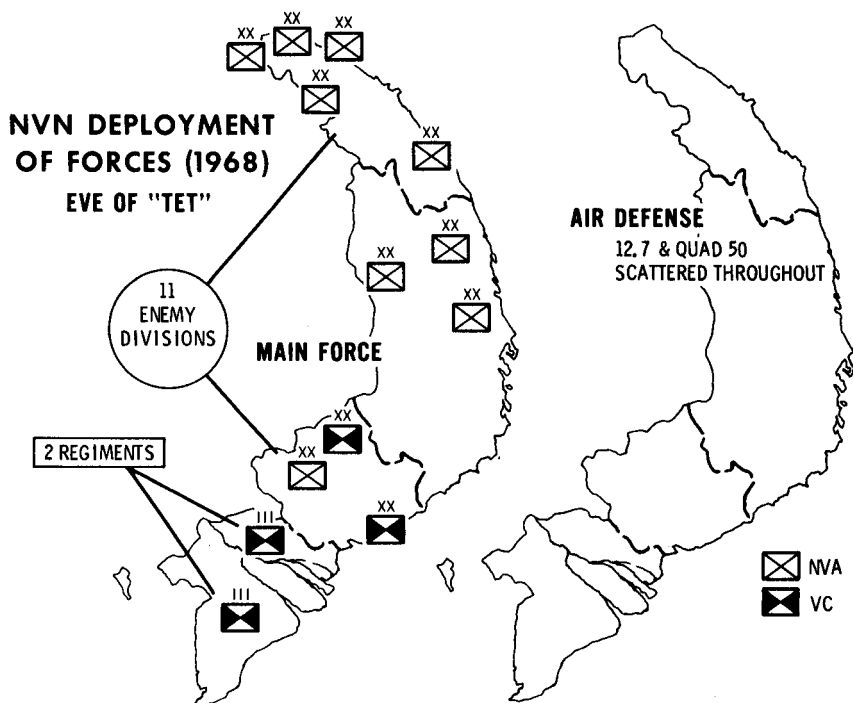

enemy ground fire were less than a half an airplane per thousand sorties. U.S. and ARVN troops could expect unlimited air support in an engagement because of the low level of anti-aircraft fire delivered by NVA and Viet Cong units.

### C. Friendly Ground Forces

The U.S. and ARVN combined numbered over a million troops. These troops were balanced in the four Corps areas according to the enemy order of battle. Since the largest concentration of enemy forces was in I Corps, this also was the area where U.S. and ARVN forces were the heaviest.

The U.S. and ARVN ground forces had a significant advantage in that strategic reserves could be flown to any part of the country in a matter of a few hours. This gave friendly units the capacity to mount a superiority of force in a short time and thus force the engagement into a decisive battle, which was to our advantage, or compel the enemy to break off the attack. The tactical flexibility of having such strategic mobility, by virtue of the size of the tactical air-lift force, reduced the ability of the enemy to mount a superior attack at any particular location.



## **D. Friendly Air Forces**

The 7th Air Force had 650 fighters based in South Vietnam and Thailand. These fighter units were equipped with F-4s, F-105s and F-100s with the F-100 having the primary task of close air support. The high performance and range of these fighters allowed close air support to be flown irrespective of the enemy ground fire and the area of the engagement. Because of the range possessed by these fighters, they could be diverted from a target in one Corps area to another so that a concentration could be achieved wherever and whenever there was a significant engagement. This ability to shift the air effort to where the ground action was, produced the most effective use of the available airpower since it assured that airpower was applied against the most worthwhile targets.

The VNAF possessed A-1s which were stationed in each of the Corps areas. Since these aircraft took so long to fly from one Corps to another, and because of their limited range, they were employed almost totally within the Corps area of assignment. If a good sized engagement happened, it was primarily USAF airpower that provided the augmentation to achieve the needed level of effort.

## USAF Fighter force in Southeast Asia



F-4 "Phantom"



F-100 "Super Sabre"



F-105 "Thunderchief"



A-1E "Skyraider"

Marine air was utilized almost exclusively in support of the Marine 1st and 3rd divisions. Under emergency conditions, however, these units could be employed by the 7th Air Force Commander as the Deputy Commander for Air MACV (Military Assistance Command Vietnam). For the most part, Marine air was utilized in I Corps during this time period. A short time later, at Khe Sanh, this policy was changed and Marine air came under the control of the 7th Air Force Commander, to be employed where it was most needed, but to be used for support of the 1st and 3rd Marine Divisions as a matter of priority, if the situation permitted.

Navy fighter and attack aircraft entering South Vietnam came under the control of the 7th Air Force Commander and were employed to support ARVN or U.S. troops according to the circumstances. Most of the Navy aircraft were used in I Corps since this was closest to Task Force 77 and was the area where there was a greater demand for additional sorties.

B-52s were flying about 1200 sorties a month and were used wherever there was a target demanding a heavy weight of effort. Since the targets were developed by MACV, this force was usually applied on pre-planned targets. However, whenever a major engagement developed the entire force could be concentrated against that situation. Due to the range and bomb load carried by the B-52s, they were employed to compensate for the lack of troops to cover suspected areas of enemy concentrations. The B-52s came to be a major morale factor for U.S. and ARVN, particularly ARVN, since the tremendous firepower delivered by these aircraft to a soldier on the ground is devastating as compared to artillery and organic weapons.

On the eve of the Tet offensive, the Air Component Commander had available a total of 1,090 combat aircraft from the USAF, Navy, Marines and VNAF. The operational ready rate of this force averaged over seventy percent and had a surge potential of 1.5 to 1.6 sorties a day per aircraft in commission



U.S. Marine Corps RF-4B



U.S. Navy A-4E Dropping 1000 lb. on Viet Cong.

for the fighters. There were more than sixteen airfields that could handle jet aircraft, plus three aircraft carriers off the coast of North Vietnam. Backing up this force were tankers which insured complete operational flexibility to concentrate on any significant target or situation from China on the North, Thailand on the West, and the tip of South Vietnam on the South.

## **E. Tactical Airlift**

Guerrilla and sapper forces continually interdicted key lines of communication in all Corps areas. During critical times of enemy assaults against outposts, it was difficult to supply and reinforce these locations by surface transportation. Thus, tactical airlift plus in-place Army helicopters became the backbone of support for all of the various outposts and for units engaged and cut off from surface logistical support.

From a strategic viewpoint, the tactical airlift force provided a flexibility in employment of ground units that was not feasible if the movement of these reserves was dependent upon surface means. COMUSMACV, by virtue of this strategic mobility, could rapidly reinforce engaged units at will. Decisions could be deferred almost to the last critical minute in order to determine enemy intentions. Once a decision had been made, movement of forces and logistical support were rapid and dependable. At any given time the tactical airlift force numbered about 280 aircraft consisting of 95 C-130s, 86 C-7s, 85 C-123s and 14 C-47s. In case of an extreme emergency this force could be augmented



C-47 "Skytrain"



C-123 "Provider"



C-7 "Caribou"



C-130 "Hercules"



C-141 "Starlifter"

by C-141s for the less demanding task of moving troops between major jet airfields for further staging.

## **F. Command and Control**

A highly developed command and control system, TACS, was in place and capable of handling the flow of aircraft from the time of departure, into the target and return to base. The TACS assured positive radar control in all areas where significant combat operations were indicated. Without this system, it would not have been possible to direct the force and shift it between areas as the combat situation demanded. A strike aircraft scheduled for a mission in I Corps could be diverted with a minimum of disruption into II Corps and turned over to a FAC for support of a troops in contact situation. Flexibility of air operations during this period was the greatest asset possessed by allied

# TACTICAL AIR CONTROL SYSTEM/ AIR GROUND OPERATIONS SYSTEM

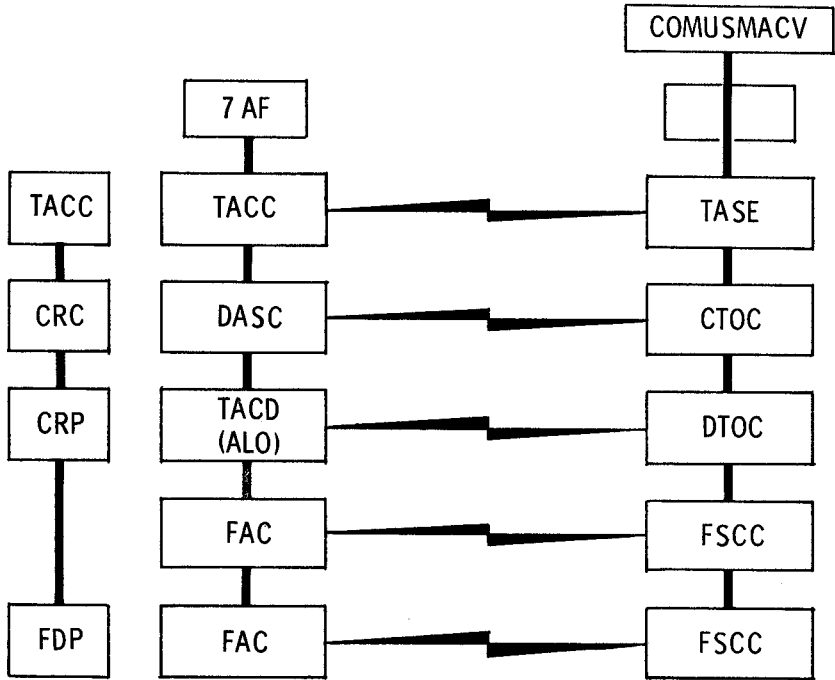

forces, since it assured a preponderance of firepower wherever needed. This is the greatest advantage an airman can provide a soldier when troops are in contact.

The Air Component Commander, with the exception of B-52s, had operational control of all the air effort. Even though there was an initial qualification on Marine air which was later changed, the Air Component Commander at the direction of COMUSMACV could and did move the air effort as needed to meet the enemy. No Corps Commander had control of these air units. The procedure provided for Corps and field force commanders to express their requirements for close air support, but it was the Theater Commander, in conjunction with his air and ground commanders, who made the final judgement on the best employment of the air effort. When situations were tense, the Air Component Commander would shift pre-planned missions into the critical area and notify the theater and appropriate ground commander of these decisions. The centralized control of air assured that the inherent flexibility of the force was not arbitrarily confined to the exclusive interest of a given Corps or field force commander when the combat in that area didn't justify the commitment of any significant air support.

## **G. Summary—Eve of Tet**

1. Centralized control of air.
2. TACS capable of handling air effort where required.
3. Airlift force capable of rapidly moving strategic reserves and logistical support of units isolated from surface lines of communication.
4. A relatively permissive air environment primarily dominated by 12.7mm machine guns and small arms.
5. Some 1,090 fighters that could be employed in any area where the situation demanded.
6. An all-weather capability to support an attack or defense of a strategic outpost or troops in a contact situation.
7. A developed logistical base that could support a sustained air effort and a surge potential of a 1.5 to 1.6 sortie rate for fighters.
8. A B-52 effort of 1,200 sorties per month.
9. A vigorous campaign in Laos and North Vietnam to interdict the flow of supplies to NVA/VC forces in South Vietnam.
10. The threat of an all-out offensive against North Vietnam to destroy all targets of military significance, including the blocking of Haiphong.





A B-52 loaded with 500 lb bombs approaches KC-135 tanker before proceeding to assigned targets



KC-135 "gas station" refueling USAF F-4's and F-105's

## V. Tet Offensive—1968

Early in January the enemy began a build-up of forces around Khe Sanh. By mid-January, there were two regular Divisions identified with a probable third Division in the area. From all indications the enemy was preparing a major assault on Khe Sanh seeking a military victory comparable to Dien Bien Phu in 1954. COMUSMACV responded with a build-up of a regimental size force of Marine and ARVN units, but relying on airpower as the major means of defending the base.

While the assault on Khe Sanh increased in intensity, the enemy simultaneously began to apply pressure at Con Thien with the objective of severing Route 9 and opening the way for an assault on Quang Tri. It appeared from these actions the enemy objective in I Corps was the assault and capture of Khe Sanh; the capture of Quang Tri; and finally, the occupation of Hue.

In the early hours of the morning of the 30th of January, the enemy launched a country-wide offensive against all the major cities and provincial capitals of South Vietnam. Except for the assaults in I Corps and II Corps and in the Saigon area, VC troops were the primary assault forces. These assault troops were accompanied by political cadres to set up control in the captured cities. By the quality of the assaults, it is apparent the enemy was looking for a political vic-



Aerial composite of Khe Sanh and surrounding geography

tory rather than a military victory, at least at the outset of the campaign. This is supported by the fact that most of the regular troops were held back and would be committed only if the situation were favorable for a decisive military victory. The primary objective was to demonstrate to the American people that the U.S. wasn't winning the war and that the people of South Vietnam were anxious for the North Vietnamese to liberate them.

## **A. Response at Khe Sanh**

The Air Component Commander was directed to apply whatever air effort was needed to halt the assault. The centralized control of the air effort permitted the immediate diversion of missions from the Hanoi area and the assumption of control of Navy strike units as well as the coordination of the B-52 attacks to harmonize with the other attacks. By these measures, a total effort of some four hundred sorties a day was mounted against the enemy surrounding Khe Sanh. In the 77-day siege, more than 35,000 tons of bombs were put on target by tactical aircraft and over 2,600 sorties and 75,000 tons of bombs were delivered by B-52s. This air effort broke the back of the assault and it is estimated that a Division of enemy troops was killed by these air attacks. During the entire period of the siege, Khe Sanh was logistically supported by air. The C-130s airlanded and airdropped more than 12,430 tons of supplies. Without this airlift support under very hostile conditions, including AAA fire, the defense of Khe Sanh would not have been feasible.

## **B. Quang Tri and Hue**

The enemy made an all out effort to capture these two strategic cities in the northern two provinces. The shifting of air effort at this time was on an hour-by-hour basis. As the attacks mounted, decisions were made between the Air Component and Theater Commander of where the effort was needed. With more than four hundred sorties going into Khe Sanh to contain that attack, additional effort was shifted from II and III Corps to stabilize the fighting at Quang Tri and Hue. Because of weather (rainy season in I Corps while dry season in III and IV Corps) it was necessary to conduct many strikes under the control of ground based radar. Nevertheless, the strikes were delivered within six hundred to a thousand feet of friendly troops. As the enemy moved into the city of Hue, it was necessary for infantry to root him out, house by house. Close air support under these conditions can be best utilized to prevent supplies and reinforcements from getting into the city.

Air attacks in support of infantry trying to take a city create too much rubble and, therefore, make the enemy defense easier while making the attack by friendly troops much more difficult. Air attacks sealed off Hue and the infantry, in house-to-house fighting, expelled the enemy in the next three weeks. Hue was the only city the enemy was able to take and hold for any length of time.



C-130 delivering supplies to beleaguered Khe Sanh

### **C. Saigon—Bien Hoa**

Concerted attacks were launched against these key cities with their airfields, logistical complex, and command headquarters. Attacks against both cities were repulsed. Close air support was a major factor in blunting the enemy attacks, along with the magnificent stand by USAF and VNAF personnel in defense of Tan Son Nhut and Bien Hoa. These air force troops held off the enemy attack until augmented by U.S. Army and ARVN troops. The combined action was a display of the finest coordination between air and ground forces in the entire war. These key facilities were defended by Air Police, soldiers, helicopter gunships, F-100s, A-1s and AC-47s.



30: C-119 on newly constructed runway at Khe Sanh, February 1971

## D. II—III and IV Corps \*

The defense of installations in these Corps areas was accomplished by shifting troops between threatened areas. C-130s and helicopters played a major role in moving troops where the enemy was causing the most trouble. Close air support was there when it was needed. During a typical day more than 300 close air support sorties were flown and more than 9,900 personnel and 4,400 tons of equipment were moved. The flexibility of airpower was never more evident.

### "TET" Statistics 30 Jan — 25 Feb 68

	VNAF	USAF
No. of Close Air Support Sorties .....	4,648	16,833
No. of Interdiction Sorties .....	1,535	
No. of Reconnaissance Sorties .....	216	
No. of Airlift Sorties .....	814	
No. of Troops Moved .....	12,200	*
No. of Tons Moved .....	230.3	*
Tonnage Expended .....	6,700	*
Combat Losses (in SVN) .....	19	44
No. of Aircraft Assigned .....	362	1,772
No. of Personnel .....	16,277	58,434

\* Not Available

## E. Summary

1. Centralized control of the air was decisive in holding Khe Sanh and the other key points throughout the country.

2. More than 3,100 close air support sorties were flown during the first week of the assault.

3. No major cities with the exception of Hue were held for more than three days by the enemy.

4. The enemy was not able to exploit initial success with regular Divisions partly because of the beating they took from air attacks when formed for the assault.

5. The TACs was the main instrument by which the Air Commander was able to move the air effort from Corps to Corps.

6. FACs played a major role in the control of air strikes since they were on the scene, and could bring the strikes in close proximity to friendly forces.

---

\* "Corps" was used to denote the four major subdivisions of South Vietnam during the period when American participation was prevalent. Subsequently, the term "Corps" was replaced by "Military Region," i.e., I, II, III, IV Corps became MR I, II, III and IV.

7. Reconnaissance operated without restraint from enemy ground weapons and was able to provide current intelligence for scheduling or diversion of forces.

8. Airlift was the key factor in the support of all forces to counteract the interdiction of surface lines of communication. During March, the tactical airlift force moved more than 300,000 tons.

9. Enemy ground fire was neutralized and did not constitute a deterrent to sustained friendly operations.

10. Quality of the fighter and reconnaissance force provided the ability to employ these forces across wide geographical areas and defense conditions because of their speed, range and maneuverability.

11. VNAF performed well in support of ground operations in each of the Corps areas. Restricted performance of the A-1 limited their use to the Corps area where based.

12. The logistical system, both USAF and VNAF, was able to handle the increased load during the surge. In-commission rates continued above seventy percent.

13. The interdiction campaign in Laos and North Vietnam had a major effect on the ability of the enemy to sustain the offensive or increase the level of forces for the offensive. The protracted period of time required to accumulate supplies, weapons and men for the assault was directly related to the interdiction campaign. Containment of the offensive within the first few days of the engagement forced the enemy to withdraw into base areas for lack of supplies and replacements to continue fighting at the accelerated rate.





Typical North Vietnamese 57mm AAA site defending key bridge north of Hanoi. Shadow of RF-101 reconnaissance plane which took the picture can be seen at right center.

## VI. Eve of the 1972 Easter Offensive

President Johnson ordered a halt to the bombing of North Vietnam above the 20th parallel on the 1st of April and a cessation of all bombing on October 30th, 1968. This provided the North Vietnamese with secure LOCs all the way from the Chinese border to the DMZ. They were not long in exploiting this decision to the utmost. The roads along the coast were improved to sustain



Russian made TU-54 Tank



Russian made T-62 Medium Tank

heavy traffic. Small ports at Quang Khe, Dong Hoi and others close to the DMZ were enlarged and developed. All of the logistical facilities were soon choked with all forms of the latest equipment. The area above the DMZ, Bat Lake, became the largest logistical depot in southern North Vietnam. Into this depot was to flow 122 and 130 mm artillery, tanks, SA-2s, SA-7s and large stocks of munitions. The North Vietnamese were able to shorten their LOC base by some three hundred miles and, as a consequence, were in a sound logistical position to launch a major offensive into MR I.

The United States responded to the build-up with spasmodic protective reaction strikes. These strikes, however, were of such limited duration they had little real impact on the overall logistical posture of the enemy. To have had a significant effect on logistical stocks would have required a sustained around-the-clock offensive for at least thirty or more days, due to the dispersal and cover of the supplies and equipment. The U.S. was not prepared at this time to confront the North Vietnamese with a renewal of sustained operations above the DMZ. Furthermore, if there was to be a resumption of the bombing in



Captured North Vietnamese anti-aircraft weapons



SA-2 Guided Missile used against U.S. Airpower in North and South Vietnam

view of the obvious intent of the North Vietnamese to wage a massive offensive against South Vietnam, such bombing should not be restrained to these logistical concentrations, but should be against the total structure of North Vietnam and its will and capacity to continue the war. Protective reaction strikes from a military point of view had no real effect on the preparation of the North Vietnamese to launch an invasion of South Vietnam. From a political aspect, such strikes likewise had little effect. The magnitude was insufficient to drive across the view to the North Vietnamese that they had better cease preparation for an enlarged war if they didn't want their country subjected to a full-scale air offensive.

The rate of infiltration on the lines of communication in Laos were the highest to date. Even though about one-third the input of logistics was coming out the other end, the North Vietnamese increased the total amount of goods to such an extent that stocks were accumulating in MR II, III and IV sufficient for a limited offensive. The interdiction campaign was destroying trucks at an unprecedented rate. The North Vietnamese were forced to request immediate replacement for some 5,000 vehicles. The fair weather road network in Laos grew from some 820 KM in 1966 to 2,710 in 1972.

The lack of authority to bomb all of Vietnam made it infeasible for the air campaign in Laos to have the desired effect on the enemy's movement of logistics. The enemy supply lines were more vulnerable in the north than in Laos

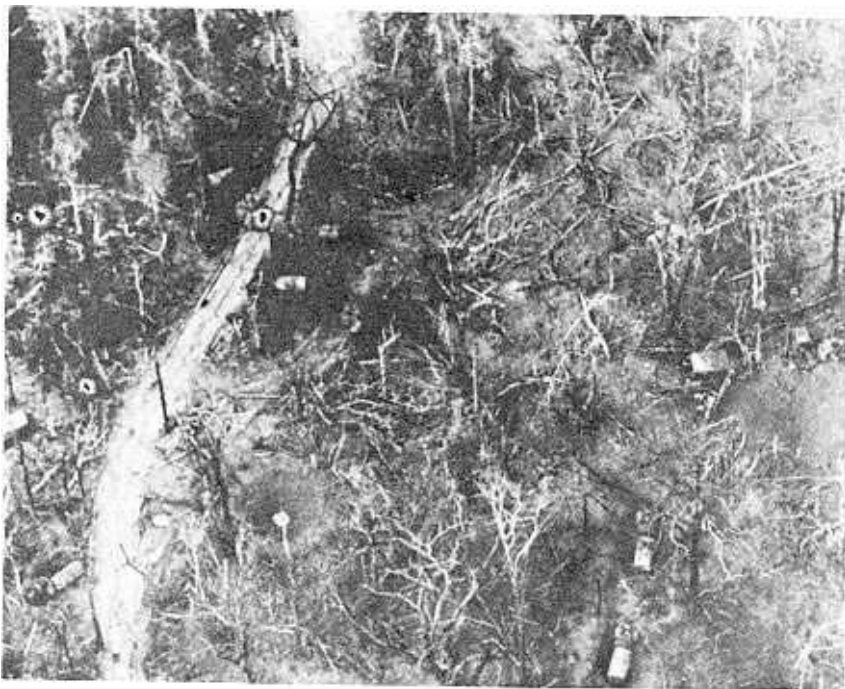

North Vietnamese "truck park" along Ho Chi Minh Trail—located by reconnaissance flights and destroyed by USAF fighters.

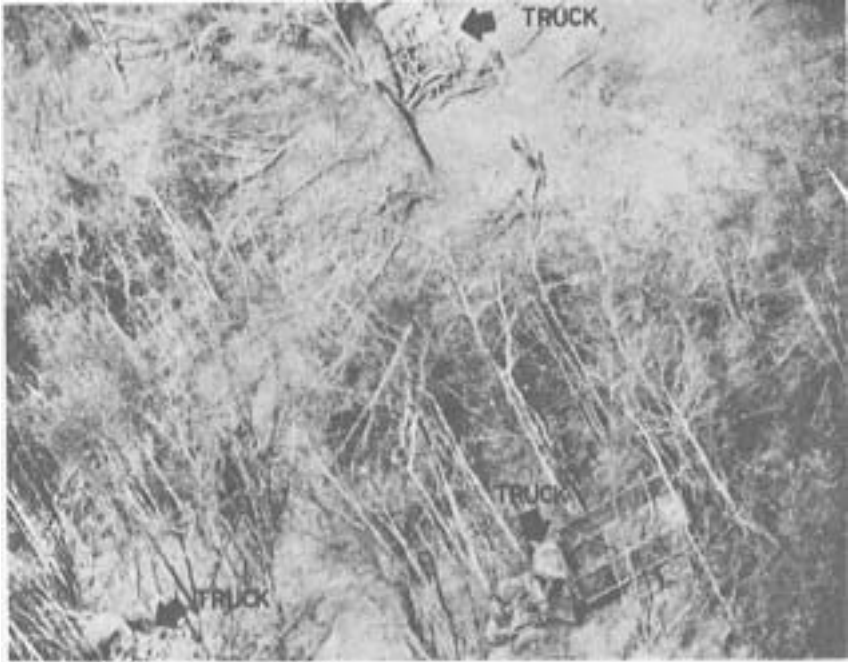

Although some got through, enemy trucks took a heavy toll along the Trail.

because of open terrain, less opportunities for by-pass, more sophisticated modes of transportation, concentrations in the ports and marshalling yards, and greater difficulty in dispersal and concealment. On the other hand, the LOCs in North Vietnam could be more easily defended than those in Laos, but the vulnerability of these LOCs in the North was the logical place to concentrate the interdiction program.

As the intent of the U.S. became apparent the North Vietnamese began to deploy more of their anti-aircraft and SAM units into Laos and above the DMZ. The first AC-130 went down over Tchepone in March of 1972 and was an indication of the defenses that would eventually spread into the DMZ and finally into South Vietnam. With the threat of a renewed air offensive against the homeland relatively low, defense units that had engaged strike forces in the north could be moved closer to the ground battle to protect the vulnerable LOCs and the build-up of forces for the coming offensive.

The South Vietnamese armed forces had gained considerable confidence and poise from the successful invasion of Cambodia. Though some difficulties were experienced in the control of large ground force units, on balance ARVN demonstrated in fighting besides U.S. troops considerable improvement from the Tet offensive of 1968. The North Vietnamese had figured ARVN would bolt which would make the takeover of the main cities a certainty. VNAF performed very satisfactorily against a higher intensity of ground fire than they had previously experienced. As a consequence of the Cambodian invasion, not

only was the enemy's logistical timetable upset, but VNAF and ARVN began to function more satisfactorily as an air-ground team.

ARVN launched an invasion of Laos (Lam Son 719) in February 1971. Although not at first, this invasion was heavily supported by USAF tactical air, B-52s and airlift forces. In addition, most of the helicopters were flown by the U.S. Army. VNAF worked side by side with the USAF. For the first time, helicopters and other low performing aircraft were subjected to heavy anti-aircraft defenses which took a major toll of these slow flying aircraft. The AAA changed from the standard 12.7 to radar directed 85 and 57 mm in the vicinity of Tchepone. From this experience, the difficulty of conducting air mobile operations in a high threat environment without excessive losses was apparent. Further, the problem of providing close air support where there are heavy defenses that haven't been neutralized prior to ground operations was again brought home. Even though the operation didn't achieve all of its objectives, it did develop the potential of ARVN to fight an intense campaign where it had overwhelming air support. The North Vietnamese were set back in their logistical preparation for a new offensive in South Vietnam for about nine to twelve months. This probably accounts for the tremendous surge that developed in the 1971-1972 dry season in preparation for the Easter offensive.

Nineteen Seventy-One was the beginning of a deliberate and calculated disengagement of U.S. ground forces from Vietnam. Vietnamization was the word of the day. The U.S. would continue to provide air and naval support for an indefinite time, but U.S. ground forces would be withdrawn on a specific schedule. The war would be fought by the South Vietnamese and the U.S. would continue to provide military and economic assistance. As the South Vietnamese demonstrated a capability to stand off the North Vietnamese, U.S. air units would be withdrawn and the task of close air support would fall on the shoulders of VNAF. On the eve of the offensive, expansions were rapidly taking place in both ARVN and VNAF. Both organizations would be strained in the process and the North Vietnamese, seeing the war taking on a different character, needed to know whether the U.S. would react to a major invasion and, if so, what kind of reaction it would be. Further, there needed to be an assessment of how well the South Vietnamese would fight without U.S. troops beside them. And finally, a major effort would improve their position for a final offensive to take over South Vietnam after the U.S. had withdrawn.

## **A. Enemy Ground Forces**

The number of North Vietnamese troops in South Vietnam was the highest to date. Almost all of the outposts along the Laotian and Cambodian borders had been under attack. Probing attacks had been made against Con Thien, Cam Lo and against firebases defending Quang Tri and Hue.

The concentration above the DMZ numbered about five Divisions. This represented approximately a three-to-one advantage over ARVN. This deployment indicated a major assault would come in MR I with a holding action

in MR III to pin down reserves so as to prevent their being used to reinforce the ARVN 1st Division in the Dong Ha-Gio Linh axis. In the central highland, concerted pressure was being exerted against the ARVN 23rd Division to contain it.

## **B. Anti-Aircraft and SAM Defenses**

Since the bombing halt, heavy anti-aircraft weapons had been shifted to the south both in North Vietnam and Laos. Both of the major passes, Ban Karai and Mu Gia, were protected by radar directed anti-aircraft fire and SA-2s. The SAM envelope had spread south from Vinh and now covered the major staging areas for the invasion into MR I. Because of the SAM threat on the LOCs in Laos, AC-130 gunships were forced into the less heavily defended areas with a reduction in effectiveness. The total number of anti-aircraft regiments in South Vietnam or on the borders of South Vietnam reached an all-time high. In essence, the enemy had been able to thin out AAA and SAM defenses in the Hanoi area and, because of the bombing halt, to shift these weapons south to provide an umbrella for his ground forces. Soviet firing doctrine was to be evident in the extensive use of AAA weapons in support of armor and infantry forces.

## **C. Friendly Ground Forces**

The U.S. had redeployed most of its combat troops to the U.S. By the end of August all ground combat troops would be out of the country. Remaining were advisors with ARVN units plus significant numbers of helicopters for air mobile activities.

ARVN morale, considering the traditional problems of corruption, low pay and weak leadership, was considered fair. The combat actions in Cambodia and Laos indicated appreciable progress in developing the capability of ARVN to stand on its own. The ARVN 1st Division, Airborne Division, and Marine Division stood out as the strongest elements of the force. General confidence prevailed that an enemy offensive to take Quang Tri and Hue could be beaten back with the massive use of airpower.

## **D. Friendly Air Forces**

United States Air Force units had been continually reduced in South Vietnam. Remaining throughout SEA were about 350 combat aircraft which compares to 1,090 at the time of the 1968 Tet offensive. Carrier forces had been reduced to two on station, but by 8 April had been increased to four. The U.S. had a demonstrated capability, however, to redeploy units from the U.S. in a matter of hours, thus it was considered that there was sufficient air strength to handle any size of an attack by augmenting the existing forces.

Build-up of VNAF had continued at an accelerated rate. Whereas VNAF had 17 squadrons and 16,200 personnel at the time of Tet in 1968, it now had 44 squadrons and 42,000 personnel. This force, although stretched by the expansion, was considered to be capable of providing close air support in an effective manner. It was not considered, however, that VNAF would be able to provide the highly sophisticated support that the USAF repeatedly did when there was a major engagement. The relatively low performance of VNAF aircraft—F-5s, A-37s and A-1s—required careful use where there were heavy concentrations of ZSU-23s, 37 and 57 mm anti-aircraft weapons. If the main thrust did develop in MR I the USAF would probably have to carry a major portion of the effort where these defenses would be strong. Further, liberal use of B-52s would be needed to help break up the concentrations of 122 and 130 mm guns, particularly since no effective counterbattery capability existed for these high velocity, low trajectory weapons. VNAF could be expected to handle most of the close air support in MR IV, but would need major assistance in Northern MR I, Western MR II and Western MR III.

## E. Enemy Air Force

During the period the North Vietnamese Air Force made repeated forays into Laos and penetrated as far south as the Mu Gia pass. Although these penetrations were at night and usually consisted of single aircraft, it represented a demonstration of increased confidence in bringing air operations closer to the ground battlefield. Coupled with these penetrations was the extension of Ground Control Intercept coverage from Vinh which indicated a capability to control fighters as far south as Dong Ha. Supporting these activities was the development of new jet airfields that would permit small penetrations into South Vietnam by staging through Vinh. It could be concluded that the North



VNAF F-5 over South Vietnam. Bolstered the A-37 and A-1 force.



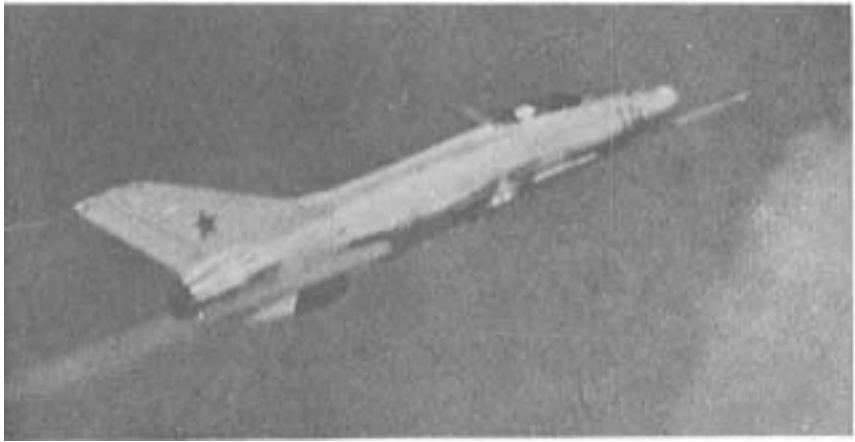

M-21 "Fishbed C"

Vietnamese Air Force was moving closer to the time when it would be in a position to engage and destroy the VNAF in the northern two regions with the departure of USAF units.

## **F. Airlift**

VNAF had taken over most of the routine airlift tasks in support of outposts and hamlets. USAF airlift units, primarily C-130s, continued the main airlift task of delivering supplies into areas where there was significant enemy ground fire. The movement of strategic reserves was dependent upon USAF airlift forces. Thus, as events later indicated, without the availability of these forces Quang Tri, Kontum and An Loc would have been captured. Even though Quang Tri was initially overrun it was taken back a short time later with tactical airlift playing a decisive role.

## **G. Command and Control**

No essential change had been made in the command and control arrangements since the 1968 offensive. Centralized control of all tactical air operations remained in the 7th Air Force. The 7th Air Force Commander, in conjunction with COMUSMACV, made the basic determination of how the in-country air effort was applied against the major points of enemy activity. VNAF was jointly fraggged from the TACC consistent with the overall priority as determined from the above meetings. ARVN regional commanders continued to submit their requirements to the JGS and these were then integrated into a proposed schedule of operations by the TACC. About a third of the force continued to be held on alert for immediates or troops in contact. COMUSMACV, based on the recommendation of the JGS and other intelligence sources, determined the targets for B-52s.

# STATUS OF FORCES-EVE OF "EASTER" OFFENSIVE (1972)

## SOUTH VIETNAMESE FORCES

- DIVISIONS 12+
- NO. OF PERSONNEL 1,061,400
  - MAIN FORCE ARVN 535,500
  - REGIONAL FORCES 282,100
  - POPULAR FORCES 243,800
- AIRCRAFT (VNAF) 1,397
- NO. OF PERSONNEL 47,000
- BOATS (VNN) 1,540
- NO. OF PERSONNEL 42,800
- TANKS & APCs
- APPROX 900 APC
- APPROX 550 TANKS

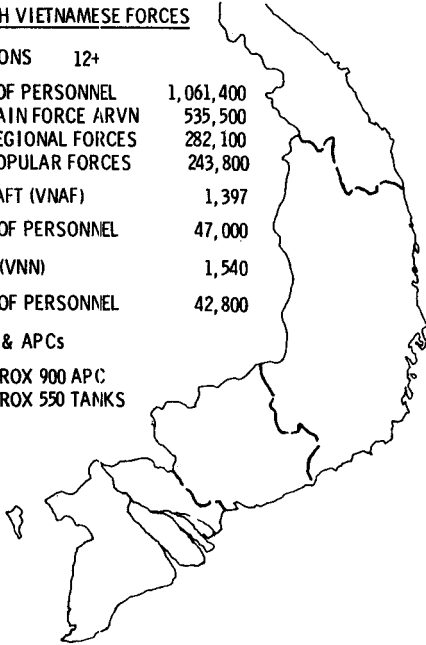

## NORTH VIETNAMESE FORCES (IN SVN)

- DIVISIONS 13+
- NO. OF PERSONNEL 228,700
  - MAIN FORCE NVA 104,200
  - MAIN FORCE VC 98,500
  - GUERRILLA 26,000
  - ADMINISTRATIVE N/A
- TANKS & APCs 160
- AIRCRAFT NONE
- AIR DEFENSE UNITS 7 REGTS
- BOATS NOT AVAILABLE

## **VII. Invasion is Launched—March 30, 1972**

The enemy launched the offensive about as predicted but in greater strength and with more modern weapons. The main attack came in MR I after a massive preparation of artillery fire. Long range guns never before employed in Vietnam were used. The 122 and 130 mm guns were a late design and previously seen only in Soviet and Warsaw Pact forces. For the first time large numbers of tanks were employed supported by infantry. Although some tanks had been used in South Vietnam since the 1968 offensive, it was only in Lam Son 719 that significant numbers were encountered. It is estimated the North Vietnamese used a total of 400 armored vehicles. Sagger anti-tank missiles were introduced for the first time and SA-7s made their appearance. For the attack the NVA had the equivalent of 17 infantry regiments, three artillery and rocket regiments, and two armored regiments, for a total of 40,000 men. From the thrust of the invasion, it appeared the enemy was seeking to cut off the northern two provinces and except for the massive and concentrated use of airpower both Quang Tri and Thua Thien provinces would have fallen. In the central highlands the objective appeared to be the capture of Kontum and Pleiku and, if the ARVN demonstrated a lack of will to fight, to move down Highway 19 to the east toward Qui Nhon and cut the waist of South Vietnam. Traditionally, this had been the basic strategy because of terrain and lack of defensive positions once the western anchor of Pleiku was given up. In the south, the objective appeared to be much more limited. Primarily to push the point of the sword closer to Saigon, but not expecting to get as far as Tay Ninh, if that. In the delta, the objective was harassment rather than the capture of any major cities as was the case in the 1968 Tet offensive.

### **A. Quang Tri**

The North Vietnamese overran Dong Ha, forcing the ARVN to fall back on Quang Tri. By 30 April Quang Tri was also lost. Heavy anti-aircraft defenses were thrown up; SA-7s took the first toll of U.S. and VNAF aircraft. On 1 May, an O-2 and A-1H were downed by SA-7s. On 2 May, two A-1s and an UH-1F suffered the same fate. Operations under 10,000 ft became too costly unless airspeeds were kept above 450 knots and countermeasures were employed. FACs were forced above 10,000 ft which made it difficult to control strikes, and they lost much of their capacity to acquire targets. Being the rainy

season, weather was a constant factor. Many sorties were flown under the control of ground based radar.

The ARVN 3rd Division was chewed up, and its retreat turned into a rout. Large quantities of equipment, tanks, artillery, vehicles and mortars were lost. Reinforcements were flown in and air support was increased. The line was stabilized, but not before Quang Tri fell. It was not until the latter part of June that ARVN was able to counterattack and eventually retake Quang Tri on the 16th of September. From the battle around Hue, however, the ARVN 1st Division emerged again as the best of the lot. On the other hand, the 3rd Division represented a major disappointment.

During the course of the battle which now had the style of a World War II engagement, tanks and anti-tank weapons were used freely. More than 267 tanks were reported to have been destroyed. The centralized direction of the air effort was in daily evidence as the weight of airpower was shifted back and forth from MR I to MR II to MR III. First it was Quang Tri, then An Loc, and then Kontum. The range and flexibility of the high performance aircraft demonstrated the validity of what had happened in previous situations where sophisticated defensive weapons were employed. During the period, the 7th Air Force Commander, through the Tactical Air Control System, including the ABCCC, controlled and targeted Marine A-4s, Navy F-4s, F-8s, A-6s and VNAF A-1s and A-37s. On any given day during the battle from early April until mid-July there were 207 sorties flown into MR I. In addition B-52s from 30 March to 30 June flew 2,724 sorties. Ten U.S. and six VNAF aircraft were lost to SA-7s during the period.

The battle for Quang Tri was won and the ground situation became stalemated. The enemy had captured all of the northern part of Quang Tri province. Airpower was the decisive element in stopping the offensive. VNAF gave a good account of itself, but the major firepower was delivered by U.S. aircraft. Of the total effort of 207 sorties during an average day, VNAF flew 45 which was about the maximum they could generate considering the limited range of their aircraft and the number of sorties that had to be flown in support of the other military regions. Quang Tri defenses reached a new order of magnitude and indicated what the future held if air attacks were to be directed against significant targets. Countermeasures similar to those employed over North Vietnam were now a necessity.

## **B. Kontum—Pleiku**

Shortly after the assault on Quang Tri, the North Vietnamese 320th regular Division led the attack on Kontum. No longer was the war being fought by VC. The Tet offensive of 1968 cleaned out most of the VC forces and now the fight was being waged almost exclusively by regular North Vietnamese—although they never admitted having these troops in South Vietnam any more than the Chinese admitted having regular communist divisions in the Korean war. The assault on Kontum was preceded by a heavy concentration of artillery fire fol-

lowed by tanks and infantry. These forces were able to move into position after ARVN, over a period of time, was forced out of Dak To and other outposts straddling the avenues of approach.

Highway 19 from Qui Nhon was cut by sappers and it became difficult to support the troops defending Kontum and Pleiku. Airlift again, as it demonstrated so many times throughout the war, was the key to survival. Airlift under most difficult conditions was flown into Kontum airfield when the enemy was on the perimeter.

Because of weather many of the air strikes were flown under the control of ground based radar or LORAN. On 28 May, during the height of the siege of Kontum City, LORAN strikes by F-4s were flown within 500 meters of friendly troops. These strikes, it was reported, probably saved the city. From 30 March to 31 May, there was a daily average of 137 sorties flown in support of MR II troops. VNAF flew an average of 33 sorties and from all accounts did a good job. VNAF bombing, when under the control of USAF FACs, was comparable to that of USAF fighters. Again, the enemy AAA defenses were much like those in Quang Tri and one AC-130 was lost to an SA-7 in the Ashau Valley. Indeed, the war in Vietnam had changed. The air was no longer permissive where there were enemy troops. No longer could helicopters provide fire suppression and logistical support. A new dimension in the war had arrived that was to become more violent for the operation of aircraft.

### **C. An Loc**

The third prong of the enemy offensive opened on 9 April against An Loc. An Loc is located in the tip of the rubber plantations which formed the route of advance from Cambodian sanctuaries into War Zone C. From War Zone C, the enemy debouched for assaults throughout Military Region Three. An Loc was a strategic location astride Highway 13 on the northern avenue of approach to Saigon.

The enemy surrounded An Loc and severed Route 13, the only land route to Saigon and reinforcements. The enemy was able to stage forces from Cambodian bases with maximum security. The assault was led by 25 tanks followed by infantry. Heavy anti-aircraft weapons were deployed and reinforced with SA-7s. The defenses at An Loc followed the same pattern as at Quang Tri. The objective was to force air operations to such high altitudes they would be ineffective, or if such operations were conducted at the lower altitudes, losses would be unacceptable.

In spite of the defenses, air support became the determining factor in the survival of An Loc. Between 25 April and 10 May, An Loc received between one thousand and two thousand rounds of artillery. ARVN troops held their positions under heavy artillery fire. The enemy made an all-out assault on 11 May when eleven tanks were destroyed and more than 800 troops were killed. Most of these targets were destroyed by airpower. USAF had an ABCCC constantly in the area with FACs reporting directly to it. Even though there were some



Soviet-built tank destroyed by USAF F-4's

problems with saturation, because of the large numbers of aircraft involved, the management of strikes was carried out in a highly effective manner. Whenever the enemy ventured into the open, a FAC was overhead with fighters immediately available. An Loc was an excellent case of the complexity of controlling a large number of fighters in a small area. It was reminiscent of the problem at Khe Sanh but on a smaller scale. On a typical day, 185 strikes were scheduled into the area, with diversions authorized if additional targets developed. There was an average of 11 B-52 sorties each day. The VNAF flew approximately 41 sorties per day.

The SA-7s forced changes in strike and aircraft tactics. Most of the low performing aircraft were forced out of the area and close air support was conducted by the high performance fighters. VNAF airlift could not handle the task.

Since An Loc was completely encircled, it had to be totally supported by airlift. SA-7s and AAA forced helicopters and C-123s out of the battle area. Initial attempts to operate C-130s with container delivery drops were costly. Three C-130s were lost and new high altitude drop techniques were initiated that made it possible to support An Loc until the siege was broken. Some 448 mis-

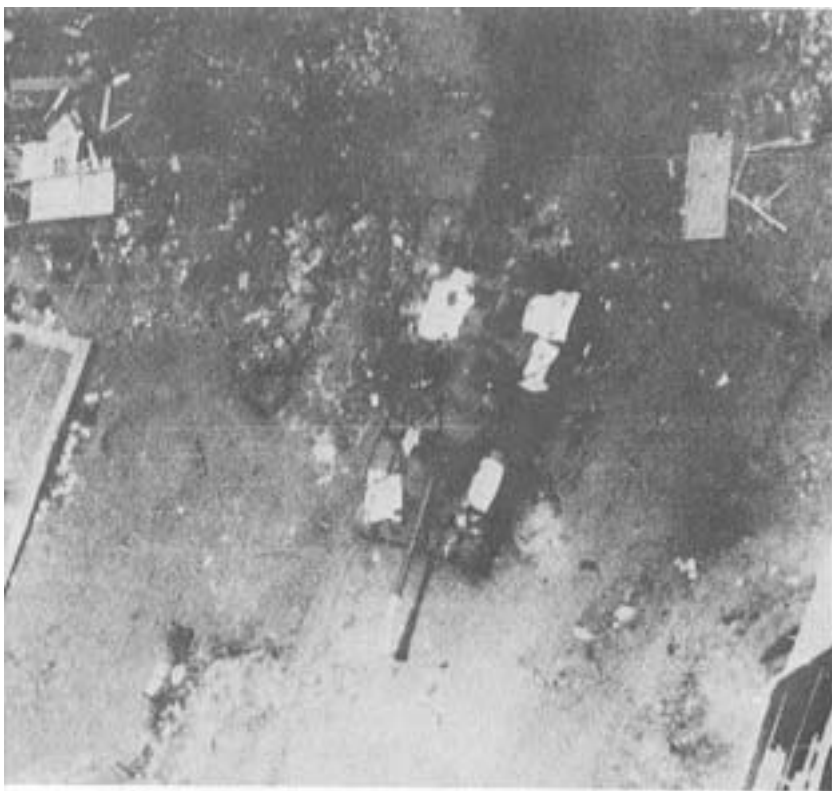

An enemy T-54 tank lies dead in the streets of An Loc. Airpower played a decisive role in the successful defense of the city.



USAF C-123 was particularly useful for operations in and out of confined landing areas. It provided much of the airlift into An Loc.

sions were flown with 3,693 tons of supplies air-dropped. Drop zones at one time were as small as 200 by 200 feet. Tactical airlift under these very difficult combat conditions again demonstrated the ability to support troops under fire as they did at Khe Sanh.

The siege at An Loc was broken in June and the major offensive in MR III came to a close. ARVN proved it could fight when led by good commanders. Again, airpower was a decisive influence in the battle. Close air support was flown around the clock. Flexibility was again demonstrated in the command and control structure and the revision of tactics to cope with the new level of defenses. On the final day the enemy was stopped half way across the airfield when fighters cut the attack to pieces and forced a suspension of the assault and a subsequent withdrawal.

## **D. U.S. Response**

With the invasion, President Nixon loosened the restrictions on the bombing of North Vietnam above the DMZ and throughout the lower route packages. In the meantime, forces in the U.S. were alerted for redeployment. TAC was directed to move F-4 squadrons, A-7s, F-111s and C-130s. The Navy was directed to increase the on-station carriers from two to five and begin the movement of two more carriers. By early May, the total U.S. airpower, including 80 more B-52s, increased from 350 to over 1,000 aircraft.

On 8 May President Nixon announced his decision to mine the ports and bomb targets throughout North Vietnam. The effect of these actions was to accelerate the attrition of supplies and equipment before reaching the battlefield. It is apparent that a resumption of the bombing had the effect of bringing the offensive to an early halt and the consequent stalemate on the ground battlefield. Further, the suspension of plenary meetings on 4 May because of North



Vietnam intransigence and lack of progress in the negotiations gave added significance to the renewed bombing offensive. The intent of the U.S. at this point was clear—we wouldn't stand by and let the North Vietnamese take over South Vietnam. If the ground action continued, the U.S. was prepared to intensify the bombing campaign to include all of Hanoi and Haiphong, which until now had been struck on a selective basis. With the retaking of Quang Tri and the beginning of the rainy season in MR III, the offensive had run its course.

**"Easter" Statistics**  
**31 Mar — 30 Apr 72**

	VNAF	USAF
No. of Close Air Support Sorties .....	4,651	} 10,659
No. of Interdiction Sorties .....	340	
No. of Reconnaissance Sorties .....	474	
No. of Airlift Sorties .....	863	
No. of Troops Moved .....	40,484	71,162
No. of Tons of Cargo Moved .....	3,388	10,968
Tonnage Expended .....	7,661	*
Combat Losses (in SVN) .....	36	15
No. of Aircraft Assigned .....	1,366	838
No. of Personnel Assigned .....	47,000	7,608

\* Not Available

## E. Summary

1. The bombing halt on October 31, 1968 permitted the NVA to concentrate units, equipment and supplies above the DMZ which provided a secure logistical base for launching the offensive in MR I.

2. Protective reaction strikes had no significant effect on the logistical sufficiency of the North Vietnamese forces.

3. Interdiction of the LOCs in Laos resulted in the highest loss to the enemy of supplies and trucks of the war, but was not sufficient to restrain the build-up as long as the LOCs in North Vietnam were restricted from attack.

4. Centralized control of the air was a decisive factor in shifting the air effort between the Corps areas and blunting the offensive.

5. The permissive air environment which characterized the 1968 offensive had now become hostile with the enemy employing large quantities of medium to heavy AAA and SAMs where ground forces were engaged.

6. Low performing aircraft were not able to operate continuously in Quang Tri, Pleiku, Kontum and An Loc because of defenses.

7. High altitude air drops made it possible to supply and support Kontum and An Loc in face of AAA and SA-7s.

8. FACs again played a major role in conjunction with the ABCCC in controlling air strikes and developing targets; however, VNAF airborne FACs generally performed poorly over their areas of operation.

9. Reconnaissance forces were able to function throughout the high threat areas.

10. The TACS continued to provide the mechanism for controlling the air effort in accordance with the decisions of the Air Commander.

11. VNAF performed at a higher level of effort than in the 1968 offensive, but could not operate in the heavily defended areas. A-1s and A-37s did not have the survivability and performance to sustain operations in areas where the enemy deployed AAA and SAMs.

12. The logistical system, both in USAF and VNAF, was able to support the rate of sorties.

13. The North Vietnamese offensive differed from the 1968 offensive in that regular troops were utilized to seize and occupy the Northern two provinces and to establish a better position for a future offensive in MR II to cut the waist of South Vietnam.

14. The decision by the President to resume the bombing of North Vietnam and to mine the ports had a restraining effect on the offensive, but, more importantly, showed the will of the U.S. not to let South Vietnam be captured.

15. Again, as in the 1968 offensive, airpower was a decisive element in that overwhelming firepower was concentrated which broke the back of the assault.

16. ARVN First Division fought exceptionally well in the defense of Hue. On the other hand, the Third Division's breakout from Quang Tri turned into a rout with much loss of artillery and armor. The Airborne and Marines fought well in retaking Quang Tri City.

## **VIII. Considerations in the Cease Fire, January 27, 1973**

The North Vietnamese throughout the war always put at the top of their list for negotiations a halt to the bombing. The importance of this military action to a settlement of the war was a major consideration in the cessation of bombing above the 20th parallel on 1 April 1968 and a complete halt to all bombing in North Vietnam on 31 October 1968. The bombing was of fundamental significance to the U.S. since it was the only real leverage we had to force the North Vietnamese to come to an acceptable agreement. The ground war in the South was controlled to a great extent by the North Vietnamese, either by electing to fight when the situation was favorable, or withdrawing into sanctuaries when combat conditions were to their disadvantage. In the case of the bombing it was just the opposite, we had the initiative and the North Vietnamese couldn't stop us. In a real sense, the war would be stopped if it were stopped by airpower applied in full strength against the heart of North Vietnam.

With the bombing halt in 1968, the way was set for the Easter offensive. The heartland was secure, LOCs to the battleground were secure, and the risk of moving additional forces and weapons to South Vietnam was minimal as long as the bombing halt or the spasmodic and isolated strikes against a few supply points remained in effect. The Easter offensive then was a test of the determination of the U.S. to resume the bombing. If the U.S. failed to react, more aggressive campaigns could be undertaken within South Vietnam leading to a final military victory. The decision to resume the bombing was a profound one in that the stage was set for throttling the intransigence of the North Vietnamese and forcing a settlement.

The bombing expanded from the 1966-1968 campaign in that most all of the significant targets, including the mining of Haiphong, were authorized. From 1 May 1972 the air campaign increased in intensity as the North Vietnamese became more difficult in negotiations. With a breakdown in the negotiations in December, the President authorized a full scale air offensive with the objective of convincing the North Vietnamese that their homeland was truly going to be destroyed if they didn't come to an agreement on a cease fire. Most all senior military leaders are in agreement that the December air campaign was the final measure that forced a cease fire and the agreement to stop the war. Many senior political officials share the same opinion.

Fundamental to the preservation of the cease fire was the implicit assump-

tion that if the North Vietnamese elected to initiate a major campaign in South Vietnam the U.S. would not respond to that action by local air support of South Vietnamese troops, but would launch a total air offensive against the North Vietnamese heartland with no respect for any target that supported the nation's will to fight. Thus, the preservation of an uneasy cease fire rested on this implied use of airpower.

From the Easter offensive of 1972 it was apparent that the ARVN couldn't stand up to the North Vietnamese Army without continuous and massive air support. This was demonstrated at Pleiku, An Loc and Quang Tri. All of these places would have fallen had it not been for airpower. ARVN was most dependent upon airpower and generally would not initiate major attacks unless airpower was assured. This is reflected in the lull of ARVN operations when the weather was bad and air support was severely limited. Further, ARVN followed the same policy as U.S. Army forces throughout the time they were in Vietnam and that was, once a contact had been established, to pull back and let artillery and airpower work the enemy over and then move in and exploit. ARVN went even further and requested air support for targets that were often more suitable for mortars. If the ARVN, at least in the near term, was to be able to handle the North Vietnamese in any kind of a large scale action, large quantities of airpower would have to be available and able to lay down a sortie rate comparable to the 1968 and 1972 offensives.

There was a pessimistic assessment that with 135,000 regular North Vietnamese troops in South Vietnam at the time of the cease fire, it was highly unlikely that a true cease fire would prevail. If, however, there was an open display of solidified support to resume the bombing of North Vietnam if there were large engagements, the localized conflicts could be managed by ARVN with air support from VNAF. It was, therefore, a hope that even though there would be continued military engagements throughout South Vietnam, these would be localized and the RVNAF would be able to contain such actions, and that with time political intercourse between the two regimes would lead to an eventual resolution of the conflict. Within this framework lay the benchmarks for the capability of VNAF.

The basic assumption surrounding the expansion of VNAF was its ability to provide close air support to ARVN under rather permissive conditions. For this reason, VNAF was not given the type of aircraft to be able to operate and function in a SAM environment augmented with heavy concentrations of radar directed AAA fire. From experience in North Vietnam and in the 1972 offensive it was obvious that high performance aircraft, backed up with ECM equipment and supporting forces, were necessary to penetrate and operate in such defenses. Where necessary to conduct many close air support missions a day in the same area, these types of defenses must be neutralized and to do that requires forces with a high degree of survivability. This was the reason in the 1972 offensive it was necessary to pull VNAF out of the SAM and AAA threat areas and to use F-4s and A-7s to handle these targets. With the cease fire we left VNAF with a force that was geared to a level of violence similar to the 1968 Tet offensive. Again, it was assumed that if there was a blatant violation of the

cease fire, U.S. airpower would be employed and it had the capability to handle whatever level of defenses the North Vietnamese were able to throw up. Further, it was assumed that with time and as the VNAF continued to mature, these more technical and complex capabilities would be injected into the force.

Another consideration of the cease fire was the assumption that a continuing level of funding for both military and economic assistance would be available. Such funding would be needed for up to five years and perhaps even longer if South Vietnam was to be viable and self-sufficient. Without such funding, the RVNAF would not be able to cope with a continuing state of conflict in which there were engagements even of a limited magnitude going on throughout the country. With the cease fire, interdiction of supplies to South Vietnam would be stopped. It was not considered feasible to provide VNAF with the sophisticated capability needed to operate against the LOCs in Laos. This would require equipping VNAF with F-4s, ECM equipment, ABCCC, laser guided weapons and other types of hardware which were beyond the capability of VNAF to maintain at this time in its life. Further, the USAF averaged about 200 sorties a day during the dry season on these LOCs. It was completely impracticable to structure the VNAF to be able to interdict the external lines of communication and simultaneously provide close air support for ARVN. Therefore, it was apparent that without the use of U.S. airpower there was no way to prevent the North Vietnamese from building up logistics stocks in and adjacent to South Vietnam sufficient to support whatever level of activity they desired.

Underlying the decision to provide the VNAF with a relatively low performing Air Force, A-37s and F-5s with no sophisticated fire control system, was the uneasy feeling that if VNAF was given high performing aircraft there would be a temptation to initiate fighter operations against North Vietnam. This would expand the war to the degree that North Vietnam would be compelled to mount a large scale campaign to take over all of South Vietnam. Thus, if the VNAF did not have aircraft capable of operating over North Vietnam, the potential for keeping the fighting at a relatively low level was enhanced and the outlook for a political settlement would be increased.

As the time approached to get South Vietnam to accept the agreement, President Thieu was adamantly opposed to any cease fire which left 135,000 North Vietnamese troops in South Vietnam. He considered this issue basic to the future of South Vietnam. As long as the enemy had this size of force, the potential for a continuous state of conflict was there. He, therefore, argued that a fundamental point in the cease fire should be the provision for withdrawal of North Vietnamese forces and verification of that action. The deadlock on this issue is reflected in the large amount of equipment that was put into South Vietnam just prior to the cease fire. The large number of aircraft given to VNAF was completely beyond their capability to maintain. It was hoped that with considerable contractor support over a period of time, VNAF would be able to handle such a large force. In any event, it became a bargaining tool along with equipment for ARVN in obtaining Thieu's agreement to support the cease fire. Thieu also believed that in the event of a major attack by the North Viet-

name the U.S. would come to his assistance with air and naval power. From the outset, it was recognized that VNAF would have a most difficult time trying to operate a force of over 2,000 aircraft. Only the most optimistic thought it likely that VNAF could manage such a force in the next few years.

## **IX. War Continued and Strategy Under Review**

### **A. Cooper-Church Amendment, August 1973**

With the passage of this Amendment, the Congress restrained the authority of the President to commit forces into Vietnam, Cambodia and Laos. This amendment could only be construed as complete disengagement of the U.S. from the Vietnam war. Forces maintained in Thailand as a visible display of intent to resume the bombing if the North Vietnamese violated the cease fire lost their deterrent value with the passage of the amendment. With so much discussion with respect to the war and the lack of support for any U.S. military action, it was evident that the Congress had no intention of permitting the President to resume the bombing irrespective of the scope of actions undertaken by the North Vietnamese.

### **B. North Vietnam's Response**

The ink was hardly dry on the cease fire until the North Vietnamese began the preparation for an eventual military action to take over South Vietnam. *Forces began to move south until a superiority of strength existed in each of the military regions.* Strategic reserves were shifted further south. Anti-aircraft defenses, now no longer needed to cope with an attack on the heartland, could be used to defend the troops now pouring into South Vietnam. Jet airfields were developed in the lower route packages as a counter-threat to VNAF. Khe Sanh was enlarged for limited jet operations.

North Vietnamese regular troops were being infiltrated at an increasing rate. Since they could mount a superiority of forces against ARVN outposts, the strategy was to lop off these outposts, cut the roads supporting such sites and then overrun them. Since the cease fire the North Vietnamese had occupied more than 100 outposts and forced the ARVN to abandon at least another 100. All of these operations took place in preparation for the final offensive which appeared to be scheduled for 1976 but with sufficient flexibility in the schedule to permit a rapid exploitation if conditions permitted. The North Vietnamese proceeded with confidence that the U.S. was out of the Vietnam war to stay.

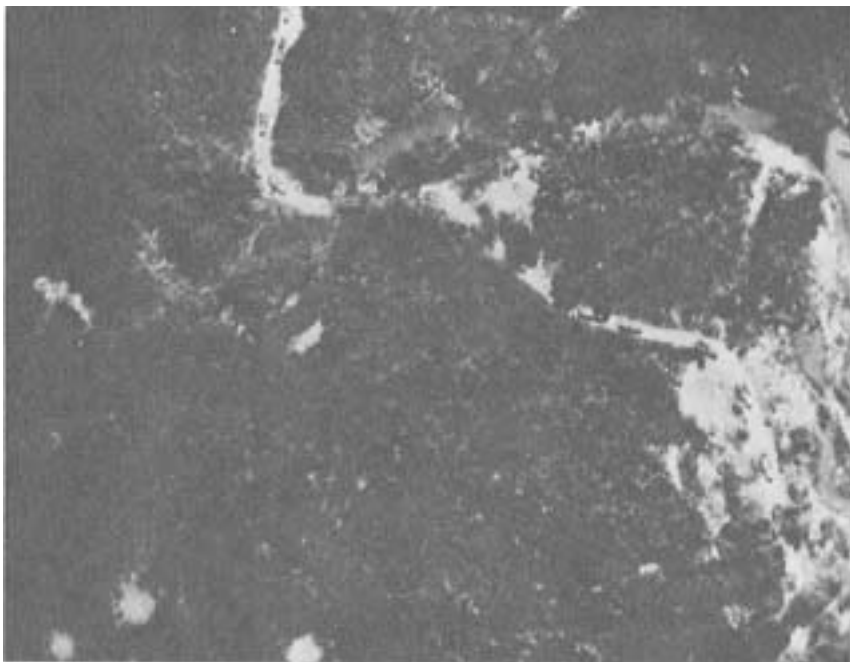

North Vietnamese truck convoy heading south on the Ho Chi Minh Trail

### **C. South Vietnam's Response**

The South Vietnamese continued to follow the strategy it had throughout the war. That is, not giving up any real estate and trying to keep the North Vietnamese off balance by extensive use of artillery and airpower, with troops being used cautiously. The leadership didn't really believe that the U.S. wouldn't come with its air and naval power if South Vietnam was about to go under.

By the summer and early fall of 1974 the strategy of attempting to hold far-flung outposts was no longer feasible. The North Vietnamese had introduced SAMs at Khe Sanh and Quang Tri, and SA-7s in all four Corps areas. These defenses were growing at an alarming rate. Eventually some 20,000 anti-aircraft defense troops would make their way into South Vietnam. Airlift, which had been the means of supporting the large outposts, was no longer feasible because of the defenses and small number of C-130 aircraft. Further, air support was no longer feasible because of the vulnerability of VNAF's A-37s and F-5s to these weapons. Under these conditions a need for a change in strategy was apparent.



In late '74 a meeting was held at Danang to discuss future strategy. Thieu attended this meeting along with his top military leaders. As a result of the review, it was concluded that a withdrawal from the central highlands would be necessary. The defense line needed to be shortened in order to conserve forces and to meet the increasing threat. In addition, military aid from the U.S. was under strenuous attack in the Congress and, at best, only a fraction of the required amount could be expected. Strict conservation of supplies, ammunition, fuel and equipment had to be practiced. There was no apparent representation from VNAF at the meeting. The Commander, VNAF apparently was not aware that such discussions were taking place. As a result of the meeting, however, instructions were issued to VNAF which necessitated a reduction of about 51% in overall flying time.

Considering the increase in enemy activity across Vietnam, it was the general understanding from the meeting that ARVN would eventually fall back on a line anchored at Qui Nhon and running through Dalat with the western anchor at Tay Ninh City. All of the northern two provinces would be given up, but Danang would be held since it could be supported by sea and the terrain was favorable for defense. To the extent feasible, the coastal cities between Danang and Qui Nhon would be held, but these would be given up if enemy pressure was too great. The JGS was not brought into the planning for such a withdrawal and there is no evidence to indicate that JGS took any subsequent actions. This meeting assumed added significance in the events that followed in March.

There had been no replacement of equipment since the cease fire. As a result, strict conservation measures were instituted. Interdicting fire was reduced and, when there were engagements, strict discipline would be exercised on the use of firepower. At a time when enemy activity was building up, which required a heavier use of firepower, the lack of funds for replenishing stocks demanded a limited use of firepower.

## **X. VNAF on the Eve of the March 1975 Offensive**

### **A. Expansion**

In 1964, VNAF had 280 aircraft and 11,276 people. Its force consisted of four fighter squadrons, four helicopter squadrons, four liaison squadrons and one support wing. This force was evenly distributed between the four Corps areas, based on the proposition that one fighter squadron was sufficient for close air support of a Corps.

By 1970 VNAF had grown to 481 aircraft and 22 squadrons. The expansion was predicated on the VNAF eventually taking over the entire in-country air support. Even with this size force VNAF was showing signs of stress in manning 22 squadrons. The main problems were in maintenance and supply. Historically the air depot at Bien Hoa had had problems. The USAF, over the years, had teams in the depot which put it back on a sound basis, only to have it slip back into trouble after the U.S. teams had been gone a few months. In the developing of a young Air Force, this area has chronically been the most difficult to solve and VNAF was no exception.

Operationally, VNAF was able, by early 1970, to take over most of the flying in IV Corps and a larger share in the other three Corps areas. The problems of weather and night operations were chronic deficiencies. On balance, however, VNAF did a fair job in supporting ARVN operations. The lack of experienced pilots to fill out the air-ground operations system was evident. VNAF did not have the people to provide trained FACs at battalion level. Consequently, the effectiveness of close air support was restrained when looking at the country as a whole. In some areas, the VNAF did exceptionally well where there were trained ALOs at Division level directing close air support.

With the decision to turn the war over to the Vietnamese as rapidly as possible, the VNAF was expanded at an unprecedented rate. This rate of expansion was more than VNAF could absorb. By the time of the cease fire, January 27, 1973, VNAF had 2,075 aircraft of twenty-five different types. It had reached a strength of 65 squadrons and 61,147 people. It was obvious that VNAF couldn't operate this size Air Force with so many different types of aircraft. The rationale for such a large force was based on the supposition that, given time, VNAF would eventually develop the ability to handle such a large force, and because of the provisions of the cease fire agreement that no additional equipment could be introduced after the cease fire, only replacements on a one-for-one basis. Thus, regardless of the validity of the request for such large

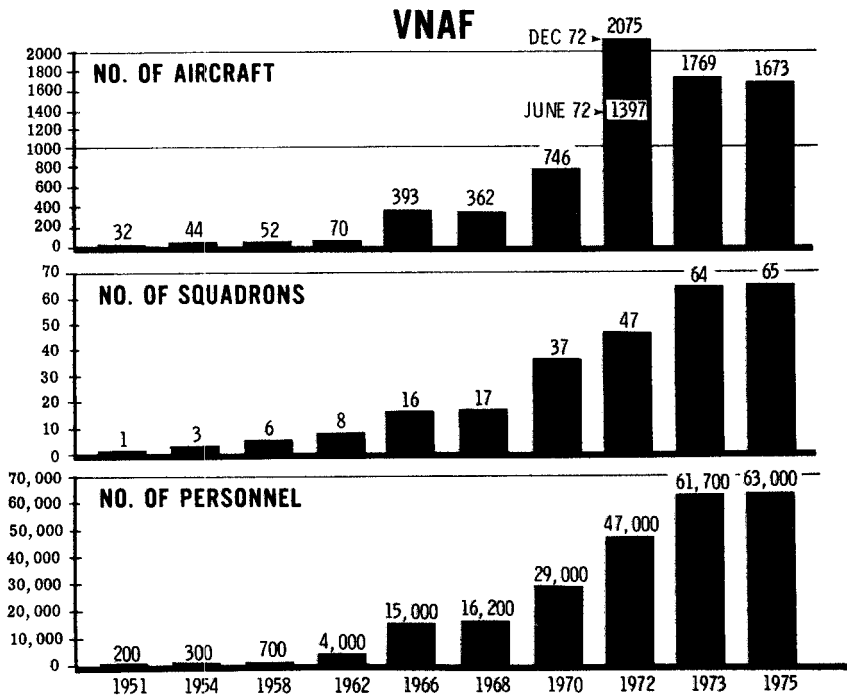

amounts of equipments, these requests were honored; an important factor in convincing Thieu to go along with the cease fire.

## B. Maintenance and Supply

VNAF made the wise decision to put 224 aircraft in storage. All of the A-1s were placed in storage at selected airfields. The condition of these war weary aircraft was such that their life expectancy was short. Even though about 500 people were devoted to the inspection of storage aircraft, the net effect was to increase the readiness of remaining aircraft. Since there had been no replacement for aircraft losses since the cease fire, the force at the end of December 1974 was approximately 1,484 aircraft. A total of 299 aircraft had been lost due to combat, operational causes or transfers.

Of an authorized manpower strength of 64,905 there were 62,585 assigned, or 96.4%. There were some shortages in skill levels but this followed about the same ratio as in the USAF. The main deficiencies were in the seven and nine level airmen. From a number of evaluations that were made, with one team visit as late as January 1975, it was concluded that VNAF maintenance was in a good condition. The skill level was sufficient to support ongoing operations. The operational ready rate was better than seventy percent for the fighters. The C-130 rate was poor because of fuel leaks and structural problems which were common to the C-130A prior to transfer to VNAF. The ready rate of these air-

craft was about 30%. The OR rate for the other aircraft was higher than the fighters with the exception of the AC-119 which had an inadequate radar which caused the utility of the aircraft to be low for adverse weather operations.

There were some problems with supply. Stock levels were low which could be attributed to a reduction in funds. Units were not replenishing bench stocks which in time would have had a limiting effect on the force, but at the time of the North Vietnamese offensive stock levels were not a limiting factor on the capability of VNAF. In December, supply fill rates from the depot were running at about 34%. Chronic problems with the depot were still prevalent although assistance by USAF teams was rectifying the trouble until political factors forced a withdrawal of these teams. The depot had progressed to the point where many advanced capabilities existed; however, VNAF still could not manage the complex logistics system. For example, the main problem in the depot was not inadequate spare parts, but accounting procedures to determine where the parts were. There was a backlog of engines for overhaul which could have been a factor with time, but did not limit the operational readiness of the force to fly a major effort in support of ARVN on the eve of the offensive.

Ammunition and fuel stocks were declining but these were sufficient for approximately 55 to 60 days at an accelerated rate of operation. VNAF had cut back about 51% in flying hours and reduced bomb loads from four to two. Upon reevaluation of this policy in late November, it was decided to return to four bombs per aircraft and reduce the number of sorties. The effect of this decision was to force ARVN to evaluate more thoroughly requests for air strikes and approve only those that were worthy of a full expenditure of ordnance. It was the opinion of USAF personnel that reducing the number of sorties increased the overall effectiveness of VNAF. Pressure had been exerted on ARVN commanders to stop requesting so much effort against ill-defined targets, such as suspected locations of North Vietnamese forces that had not been confirmed by hard intelligence. It is concluded that even though stocks were declining, this factor did not limit the capability of VNAF to fly an all-out effort of several weeks' duration.

### **C. Operations**

As the enemy moved more air defense forces into South Vietnam, VNAF had a lesser and lesser capability to strike enemy ground forces and the supplies supporting those forces. By March 1975, the North Vietnamese had SA-2 coverage of MR I as far south as Quang Tri. Khe Sanh, a major supply and staging area, was protected by SA-2s. All of the border area around Kontum, Pleiku and the Parrot's Beak in MR III was protected by radar-directed AAA and SA-7s. VNAF lost 28 aircraft to SAMs from 28 January 1973 to December 31, 1974. There were no replacements for these aircraft.

As a result of these defenses, a policy was in effect limiting VNAF flights above Hue and west of Highway One. This area was the most heavily defended by the North Vietnamese. Whether the VNAF was restricted from this area

because of losses or because of implicit recognition that the northern part of these two provinces had been permanently lost to the North Vietnamese and attacking such areas with aircraft would be in effect attacking North Vietnam with a potential for retaliatory action is not known. The effect of this policy, however, was to neutralize the effectiveness of VNAF against hard targets such as troops, tanks, artillery, vehicles and supplies.

VNAF was not provided with ECM equipment and, therefore, could not function in these defended areas. The enemy had in essence a secure sanctuary to stage, prepare and launch forces in all of the four military regions. Even if VNAF had ECM it is questionable whether it could have sustained operations in these high threat areas with such low performing aircraft. Again, the aircraft possessed by VNAF were predicated on the assumption that a relatively permissive air environment would prevail and that these low performing aircraft would be able to function in such a situation. It was assumed that USAF would be reintroduced if the North Vietnamese escalated the fighting where defenses were comparable to those over North Vietnam. In effect the VNAF did not have air superiority and as a result was not able to bring the enemy concentrations under sustained attack prior to the offensive.

As noted in the 1968 and 1972 offensives, airlift played a major part in moving troops to fill in where major attacks developed. The timely movement of troops and the support of those troops provided flexibility to ground force commanders that could not be obtained in any other manner at that time. In both offensives, LOCs were cut and supply by air was the only way many of the isolated forces could be supported. Without this support these forces would have been overrun because of lack of reinforcements, ammunition and food. On the eve of the 1975 offensive only a fraction of the former airlift force remained. VNAF had 32 C-130As, but only nine were in commission on any given day. With this size of force, RVNAF in no way possessed the ability to shuffle units to counter the buildup throughout all of the critical areas in MR I, II and III. Because of this limitation on tactical flexibility, much more intelligence was needed and more thorough planning was fundamental. Both of these offsetting factors were not prevalent on the eve of the offensive.

According to reports as late as December, the Tactical Air Control System was functioning in a satisfactory manner although complete use of the system was not being made. The in-commission rate was reported as 90% and this was based on a team visit in January 1975. It is assumed, therefore, that the TACS was fully capable of handling the sorties VNAF could generate in the offensive.

It is estimated the VNAF had approximately 390 fighters—A-37s and F-5s. With an in-commission rate of 70% there should have been a force of 273 aircraft available for operations. Based upon USAF experience with A-37s in Vietnam, VNAF should have been able to generate a sortie rate of at least two per operationally ready aircraft. Reports indicate that there was some difficulty in meeting such a rate. It is noted, however, that in December the programmed rate was less than one-half a sortie per aircraft operationally ready. The program was 4,246 sorties which at that point didn't reflect the severity of the North Vietnamese threat. It is noted that, during the 1972 offensive, the fighter



VNAF A-1H fighters attacking Viet Cong positions in South Vietnam

force averaged about 504 sorties per day without having to go to a full out effort.

VNAF had a potential capability comparable to the 1972 offensive if it could sustain a rate of two sorties per day per aircraft in commission. From the point of view of sortie generation, VNAF had sufficient capability to put up a major effort. This does not take into account the defenses and losses that would have been incurred. If VNAF had flown at these higher rates, attrition would probably have been approximately three aircraft per hundred sorties. This rate is fairly consistent with USAF and Israeli experience when operating in very high threat areas. Without replacement aircraft, VNAF would have had a limited ability to sustain operations. In the case of an all-out offensive to conquer South Vietnam, it would have been proper to have sacrificed the force in a last ditch stand hoping the U.S. would replenish the force or perhaps introduce USAF fighter units.

Helicopters had less utility than in the 1972 offensive. With the build-up of SA-7s and AAA, helicopters could not operate in the areas where North Vietnamese troops were deployed. Helicopter assaults were not feasible for restoring lost positions where SA-7s and concentrated AAA were deployed. As a consequence, much of the mobility that U.S. Army forces achieved by helicopters in the 1968 period was reduced in the 1972 offensive and was almost completely withdrawn on the eve of the 1975 offensive. Yet 24 squadrons of VNAF were equipped with helicopters. At the time of the cease fire there were 929 possessed and, by the end of December, VNAF had lost 154. The changing character of the war—from a permissive air environment to a hostile one—neutralized the employment of helicopters except under select circumstances. This follows the same pattern observed during Lam Son 719, the 1972 Easter offensive and the Israeli war of October 1973.

The VNAF didn't have sufficient tactical airlift to provide the needed strategic mobility throughout Vietnam. On the other hand, it had a disproportionate amount of resources tied up in helicopter lift. It couldn't employ such forces for shifting ground units between Military Regions to counteract North Vietnamese superiority of forces because of the density of enemy defenses and the helicopter's lack of range, speed and payload.

VNAF lost four of its RF-5s prior to the offensive. The SAM defenses precluded the use of these aircraft over the significant target areas in MR I, II and III. Furthermore, the camera installation was not capable of providing the type of details required for air-ground operations. The VNAF reconnaissance cycle was too slow and processing equipment was not of the latest type. The EC and RC-47s were forced out of potential target areas because of AAA and SAMs. When they did fly in these hot areas, it was above 20,000 ft. The consequence of these restrictions was the denial of essential and timely intelligence concerning the disposition and location of North Vietnamese forces. The reconnaissance force was not designed to function in a hostile environment.

One of the most detailed and timely sources of information for the targeting of tactical air strikes was the FAC. When U.S. forces were deployed in South Vietnam, FACs literally covered the entire country. They produced most of the troops in contact targets which were the most productive targets. By the time of



UH-1 "Huey" on a "search and destroy" operation in South Vietnam



the 1972 offensive, FACs were being forced out of critical areas by defenses. With the onset of the 1975 offensive the air situation was such that FACs were not able to operate where there were North Vietnamese troops in contact. VNAF FACs were the weakest link in the air-ground operations system. Traditionally FACs had not been given the prestige and the authority to function adequately. With the limitations in these assets there was a deep void not only in intelligence but in the ability to control strikes that were in close proximity to ground troops. On the eve of the offensive, the main cog in delivering close air support was not up to the task. It would have been necessary to use high speed FACs in F-4s to bring targets under attack in the high threat areas as was done in the 1972 offensive and in North Vietnam. VNAF did not have the capability to employ FACs in the changed war.

Some sorties by Binh Thuy A-37s were being flown above 10,000 feet in support of the MR III Commander. These were mostly ineffective and brought considerable criticism of VNAF from both U.S. and ARVN. VNAF conducted a large number of these strikes under radar control since they didn't feel they could withstand the losses to SA-7s. In MR I, II and IV, strikes were conducted at operational altitudes under 10,000 feet except when weather was bad, in which case ground radar was used. There was no apparent restraint on the part of VNAF units to accept losses in the latter three military regions if necessary to support troops in contact. Reports indicate ARVN commanders were satisfied with close air support received in these regions. The situation was corrected in MR III prior to the offensive and the MR III commander expressed satisfaction with the support he received from the 4th Air Division at Binh Thuy.

## **D. Intelligence**

There was adequate intelligence on the build-up of the North Vietnamese force. The magnitude and character of forces were well established from the pictures taken of equipment coming down the LOCs and other information with respect to the flow of personnel and units. All of this information indicated a capability to launch a major offensive although it was generally believed that the main attack would come in 1976 to coincide with the election. There were indications, however, the enemy would exploit any favorable opportunity. The objectives of the offensive for 1975 were considered to be limited, particularly to improving positions in all Military Regions. A major offensive was not anticipated in MR III and IV because of the short time remaining before the rainy season. Thus, the main fighting would probably be in MR I since the dry season was approaching and the terrain would be suitable for armored vehicles.

The exchange of intelligence between VNAF and JGS was not satisfactory nor had it been for a number of years. The VNAF was never considered part of the inner circle and, therefore, suffered from a lack of intelligence acquired through other than aerial vehicles. Since the MR Commanders exercised command of VNAF units assigned to a given military region, VNAF intelligence

requirements were considered satisfied by the TOC of the Military Region. Since the Corps Commander had such absolute control, and VNAF units didn't operate independently of the Military Regions, there was no need for the VNAF to have the same relationship with JGS. Air operations suffered because of this inadequate intelligence relationship. The full range of VNAF capability became arbitrarily restricted to the span of concern of the Military Region Commander.

## E. Command and Control

There was a retrogression of the command and control of VNAF units by the time of the 1975 offensive. Whereas, during the 1968 Tet offensive, VNAF was fraggd from the TACC in conjunction with USAF units, it was now almost completely fraggd from the military regions. The TACC had no authority to use units from one military region in another, nor did the MR Commander normally know of tactical emergencies in other regions. During the contest for Phuoc Long Province, however, VNAF and all MR Commanders were aware of the situation and VNAF flew sorties from both MR II and MR IV in support. This action was directed by President Thieu. With this exception, however, targets were not developed to exercise and exploit this traditional flexibility of airpower. The MR Commander, by authority of Thieu, had complete control of all units assigned in his region. These regional commanders almost exclusively employed VNAF units where troops on the ground could see these

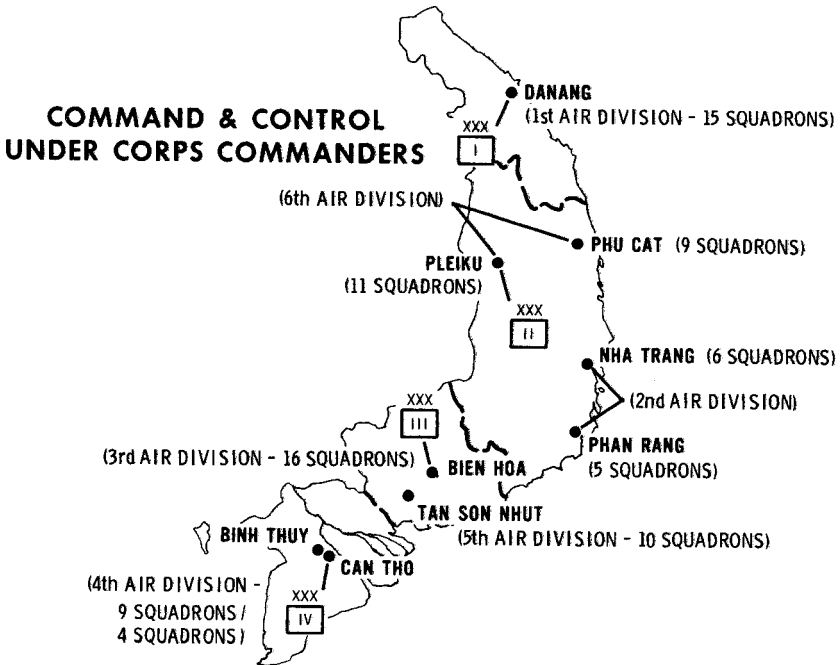

aircraft providing support. Targets along the LOCs were rarely cleared for attack, thereby giving the North Vietnamese freedom of movement over most of the LOCs except where these LOCs were in close proximity to positions being defended by ARVN regular troops or RF and PF forces.

On the eve of the 1975 offensive, command and control was totally inadequate to cope with the threat. If versatility was ever needed it was needed at this time in order to rapidly move the only flexible firepower available, airpower, from area to area to counter the local superiority of the enemy. Centralized control of air, the most fundamental principle for decisive air operations, was totally absent. VNAF headquarters had no identified authority for the employment of the total air resources. The VNAF was divided up into small packets as had been done in the early days of World War II and as a consequence was improperly employed by Corps Commanders whose vision was limited to the situation in his Corps area. JGS had only one senior airman on its staff and took no active role in the strategic direction of the Corps nor in the establishment of across-the-board priorities for the employment of the air resources.

## XI. Ground Situation, February 1975

The ground situation continued to deteriorate in December and January. The enemy had stored enough supplies to support an all-out offensive. It was estimated that between 15 and 20 months of supplies were on hand. Action in MR I was relatively light. The railroad between Danang and Hue had been cut. Heavy rains had washed out many bridges. The airfield at Phu Bai had been closed because of heavy shelling. Forward positions had been under artillery fire from 130 and 122 mm guns. VNAF had not been permitted by the MR I Commander to operate north of Hue, yet it was estimated that the North Vietnamese had at least six divisions in the area of the DMZ.

In MR II heavy rains had reduced fighting on both sides. The enemy had an estimated three Divisions in the area and more than 360 anti-aircraft guns. VNAF had conducted some strikes against LOCs but these were limited be-

### STATUS OF FORCES-EVE OF "SPRING" OFFENSIVE (1975)

#### SOUTH VIETNAMESE FORCES

● DIVISIONS	13+	
NO. OF PERSONNEL	662,600	
● MAIN FORCE ARVN	180,600	
● REGIONAL FORCES	289,000	
● POPULAR FORCES	193,000	
● AIRCRAFT (VNAF)	1,673	
NO. OF PERSONNEL	63,000	
● BOATS (VNN)	1,507	
NO. OF PERSONNEL	40,258	
● TANKS & APCs		
APPROX 880 APCs		
APPROX 350 TANKS		

#### NORTH VIETNAMESE FORCES (IN SVN)

● DIVISIONS	11+	
NO. OF PERSONNEL	375,000	
● MAIN FORCE NVA	} 225,000	
● MAIN FORCE VC		
● GUERRILLA	40,000	
● ADMINISTRATIVE	110,000	
● TANKS & APCs	600	
● AIRCRAFT (IN NVN)	342	
● AIR DEFENSE UNITS		
	23 AAA REGIMENTS	
	1 SAM REGIMENT	
● BOATS	39	
NO. OF PERSONNEL	3,000	

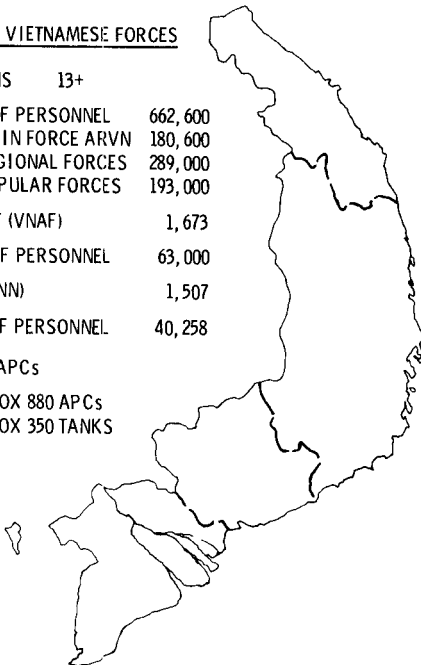

cause of weather. Most of the sorties by A-37s were flown under the control of ground radar. A heliborne operation was attempted against Throng Nghia, west of Kontum City, but enemy ground fire forced it to be withdrawn. VNAF supported the operation, but ground fire was too heavy for A-37s. The enemy continued to interdict Highway 19, the primary line of communication to Qui Nhon.

As in previous campaigns, the enemy activity in MR III was at a very high level. The dry season has traditionally been the time for major offensive operations in this area. The government position deteriorated very rapidly. On January 6, Phuoc Binh fell, which is the provincial capital of Phuoc Long Province. For the first time in the war the government had to give up an entire province. With the loss of Duc Phong airfield, the government lost the most forward airfield for the support of troops in the area. Two C-130s were destroyed at this airfield during the period. After the loss of Phuoc Long, the enemy stepped up pressure on Tay Ninh and threatened to open the gate to Saigon down Highway 13. Bien Hoa airfield came under increasing artillery and rocket fire.

VNAF was flying air support missions throughout the period, averaging forty-five to fifty sorties a day. Heavy anti-aircraft fire and SA-7s had driven up the altitude for close air support and FACs were being forced out of the area where troop engagements were taking place. The NVA was making more frequent use of tanks with infantry in support.

Although activity in IV Corps remained high, most of the attacks were by sapper teams against RF and PF outposts. Some interdictions had been made on Route Four but it was open most of the time. VNAF averaged about thirty sorties a day in support of isolated, small unit actions.

In summary, the enemy was in the best position of the war to launch a major offensive. It was estimated the enemy had more than thirteen Divisions in-country with a capability of moving the remaining reserve of some seven Divisions within a matter of a few weeks. Logistics were in place and adequate for an all-out offensive. Secure LOCs existed from MR IV to Hanoi. The threat of U.S. resumption of bombing was almost non-existent as a result of the Cooper-Church Amendment. The loss of Phuoc Long Province had a major psychological effect on the outlook of political and military leaders in the Saigon area.

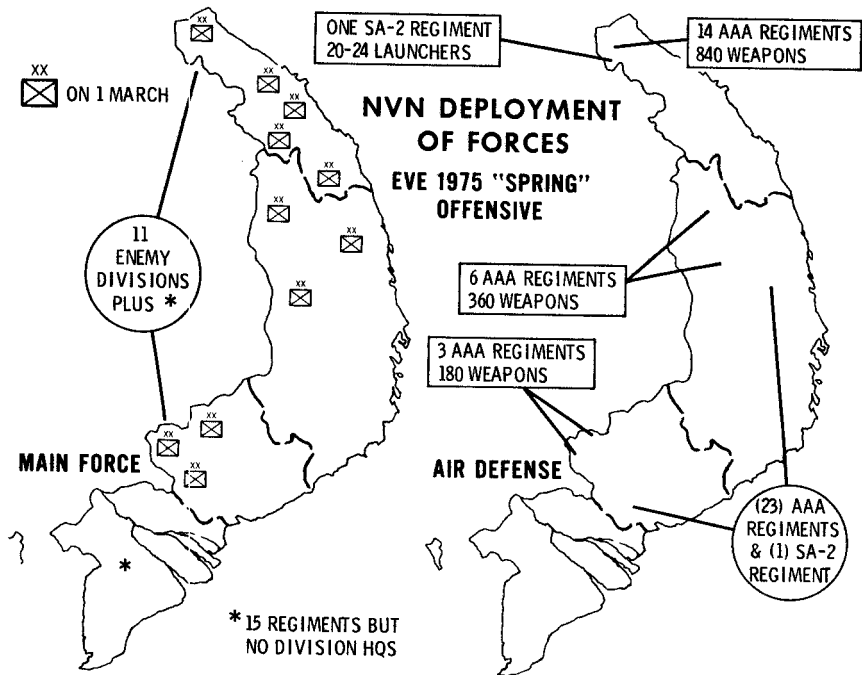

## **XII. North Vietnamese Offensive of 1975**

### **A. Ban Me Thuot**

This city has strategic value in terms of its control of Highway 14 to Pleiku-Kontum and Highway 21 to the coast. In the event of loss of Highway 19 from Qui Nhon to Pleiku, it would be most difficult to support troops in the central highland. It was soon apparent that the enemy's intent was to isolate all of the forces in the central highlands and then mount an attack against each element in turn. Highway 19 was cut in more than nine places as a prelude to the attack on Ban Me Thuot. Thus, it was essential that Highway 14 be secured in order to assure support of the forces around Pleiku.

On the night of 9 March the enemy opened a major attack against Ban Me Thuot. More than four thousand rounds hit the city in advance of the tank and infantry assault. By daybreak more than one-half of the city was in enemy hands and before the day was out both airfields were lost. VNAF flew more than 200 sorties in support of the ARVN 23rd Division. President Thieu ordered the city to be held at any price, but the North Vietnamese continued to advance. By the 14th, the entire city was in enemy hands and the 23rd Division had been severely mauled.

With the fall of Ban Me Thuot, both the MR I and MR II Commanders became concerned that this was the beginning of a country-wide offensive, and that the enemy would try to isolate the central highlands by slicing through to the coast and thereby sealing off support for the northern half of the country.

VNAF was active throughout the fight for Ban Me Thuot. It mounted a modest effort in midsummer. There is no evidence to indicate a surge nor were there reinforcements from units in the other Corps areas. This is consistent with the attitude of Corps Commanders not to make air units available for support outside of the Corps to which they are assigned. Apparently, the North Vietnamese were surprised at the ease with which Ban Me Thuot was taken, since there wasn't an immediate follow-up of the initial success.

### **B. Realignment of forces in MR I**

Early in March President Thieu made the decision to pull the 1st Airborne Division from MR I and move it to MR III to act as a reserve for forces defending the Saigon area. As a result of the loss of Phuoc Long Province, Thieu had

become concerned about defending the approaches to Saigon. Lt General Truong, MR I Commander, was advised that one brigade would move immediately and the remaining brigades by the end of the month.

The view had previously been expressed by the MR I Commander that he didn't have enough troops to defend all of MR I and that he needed additional reinforcement. As early as the summer of 1974, it had been decided that there were no troops available and that it might be necessary to give up some of the exposed positions in Quang Ngai Province and even Quang Tri and Hue if the situation became more unfavorable.

In spite of the additional effort by the MR I Commander to retain the Airborne Division, the decision held to proceed with the redeployment. The staff of MR I was directed to prepare plans to fall back from Quang Tri and Hue, but to hold Danang at all cost. The major defense line for Danang would be located at the Hai Van pass which is the best terrain for defense. The 1st Air Division Commander at Danang was not aware of such plans nor was he brought in for a discussion of how the air could best support these moves. The Commanding General, VNAF, was also not aware of these discussions. This is not surprising since he had not been a participant in past strategic decisions.

### **C. Cam Ranh Bay Meeting—14 March**

Thieu called a meeting on the 14th of March at Cam Ranh Bay to discuss strategy. VNAF was not represented, yet airpower was fundamental to any strategic decisions for the defense of South Vietnam. Airpower was the only force that could help offset the advantage in numbers and firepower possessed by the North Vietnamese.

As a result of these discussions, Thieu made the decision to give up Pleiku and Kontum in order to shorten the line of defense and provide forces for a counterattack at Ban Me Thuot. Apparently General Phu interpreted this decision as requiring an immediate pullback from Pleiku and Kontum. The others apparently understood that the decision did not require an immediate withdrawal but was to be executed toward the latter part of the month in a gradual fashion. This interpretation would be consistent with previous discussions in which it was generally understood that an orderly withdrawal from the central highland might be necessary.

### **D. Retreat from Pleiku – Kontum**

Maj General Phu, Commanding General, MR II, on the evening of the 14th of March issued orders for the immediate withdrawal of forces from Pleiku and Kontum. The headquarters of MR II would begin immediate movement to Nha Trang and the Deputy Commanding General of MR II would act as the rear echelon commander.

Brig General Pham Ngoc Sang, Commanding General of the 6th Air Division, was given forty-eight hours to evacuate his aircraft and people from Plei-



ku airfield. Sang made immediate plans to move his equipment and people. He dispatched his deputy to Saigon to see General Minh, Commanding General, VNAF, about getting some C-130s to make the move. This was the first time that General Minh was aware that a decision had been made to evacuate Pleiku, yet one of his air divisions was involved.

Minh, with the approval of the Army Transportation Division which had operational control of the airlift resources as a theater asset, approved the use of C-130s for the evacuation. Throughout the night C-130s shuttled in and out of Pleiku moving equipment and people to Phu Cat and Phan Rang.

There was no contact between ARVN and North Vietnamese troops. Artillery shells began to fall near Pleiku, but the enemy had not moved out for an assault on the airfield and other installations. At this point, VNAF was not flying missions against the enemy in this area. Most of the people in the 6th Air Division were occupied in getting their families out. The weather on the 15th was bad and no C-130s were flown into Pleiku. In the meantime, panic had broken out and people were streaming out of the area under little control.

As the weather cleared on the 16th, General Sang elected to try and get the rest of his people out in daylight even though it would be hazardous. By this time, nearly all operationally ready aircraft and almost all of the people of the 6th Air Division had been flown out. The Division Commander did a tremendous job and exhibited great courage in the handling of a chaotic situation.

There were 36 aircraft in flyable storage. No attempt was made because of time to put these aircraft in commission. Sixty-four aircraft were left behind. Most of these aircraft were not destroyed. There is contradictory evidence as to the degree of destruction of fuel and ammunition dumps. The Control and Reporting Post (call sign Peacock) was partially destroyed and reduced significantly the control of any operations in the central highlands.

Because of the interdiction of Highway 19, the main route to Qui Nhon, the column of ARVN and refugees was shifted to an undeveloped road. VNAF attempted to provide support to this column from Phu Cat. The North Vietnamese employed artillery against the column irrespective of civilian refugees. VNAF was engaged in dropping some supplies but there is no evidence to indicate a major effort against the enemy artillery and ambush sites. There is no indication that an emergency plan was put into operation to use airpower from other Corps areas to help stabilize the retreat. Once the retreat began, it was a rout all the way to the coast.

## **E. Danang Falls**

General Truong returned from conference with Thieu on the 13th of March and held a meeting with his staff. There is no evidence that the 1st Air Division Commander, Brig General Nguyen Duc Khanh was in attendance at this meeting. Truong detailed his strategy for the defense of Danang. He directed the preparation of plans that provided for the orderly withdrawal of forces from Quang Tri and Hue with the major defense line to be anchored at the Hai Van

pass. The 1st, 3rd and Marine Divisions would be committed with the 2nd Division held in reserve. The 2nd Division would pull back from exposed positions to the west of Tam Ky and screen against enemy moves to take Quang Ngai City from the south. Maximum conservation of resources would be in effect until the main battle for Danang was joined. Particular measures would be initiated to conserve air units since these forces were the offsetting balance against the superiority of North Vietnamese forces.

With the situation in Pleiku now unraveling, instructions were issued on the 16th to begin a withdrawal to the defense line. Three North Vietnamese Divisions were now pressing forward threatening the high ground west of Hue. Within the last few days over fifteen hamlets had been overrun. As the refugees and RF and PF troops started to move, the roads became clogged and panic was beginning to erupt. Although there had been some rocket attacks against Danang airfield, the 1st Air Division had suffered no major loss in operational capability at this time. In accordance with the MR I Commander's directive, VNAF flew very few sorties. There is no evidence to indicate consideration of an accelerated sortie rate to facilitate the withdrawal.

General Lanh, Deputy Commander of VNAF, flew into Danang the night of the 27th and told Khanh to get all of his flyable aircraft out. Danang airfield was under continuous artillery fire on the 28th and 29th. Most of the evacuation of some 130 aircraft was done under these adverse conditions. Approximately 180 aircraft including 33 A-37s were abandoned because of artillery fire, confusion and breakdown of airfield security. VNAF security troops were overpowered by ARVN forces trying to get out.

The rapid disintegration of the situation in MR I negated plans for the defense of Danang. The mass of refugees streaming into Danang made an effective defense of the area almost infeasible. Much of the disorganization in remaining military units can be attributed to the chaotic condition created by the mass of refugees. The breakdown in command and control and morale was inherent in such a situation. Even under the best circumstances, executing an orderly withdrawal with no large body of refugees to contend with is a difficult maneuver.

Some facilities at Monkey Mountain were destroyed which was the alternate command post for MR I. To what extent the CRC was destroyed at that time is an open point. Because of the lack of leadership and timely decisions, most of the people of the 1st Air Division were not evacuated.

Whether Danang could have been held under the circumstances is questionable. The breakdown in leadership, poor morale, poor discipline and disintegration of unit integrity made an effective defense almost impossible. The lack of planning and exercise of initiative led to a situation that was out of control. Airpower, when it should have been committed and where it could have done the most good to at least slow the advance of the enemy, was not employed. The assignment of VNAF units to Corps commanders resulted in the total ineffectiveness of these units. Perhaps it was too late in the day for holding Danang, but concentrated use of airpower against the exposed elements of the North Vietnamese forces would have made a fight for Danang rational because of the effect it would have on the establishment of a new defense line further south.

With the debacle at Danang, demoralization spread throughout the rest of South Vietnam and was a major factor in the complete disintegration of the remaining forces.

## **F. Coastal Cities Fall**

With the decision to evacuate Pleiku, MR II established its headquarters at Nha Trang. The strategy was to hold as many of the coastal cities as feasible, but to eventually fall back on a main defense line that went from Nha Trang through Dalat and was anchored at Tay Ninh City. This defense line would protect the major population centers of the delta as well as the rich rice growing areas of the south. It was thought by pulling back on this short defense line airpower could make it so costly to the enemy that a stalemate would emerge, giving more time for a possible political settlement.

With the fall of Danang, one coastal city after another fell in rapid order. Chu Lai was given up in disorder by the 2nd Division on the 26th of March. Some heroic fights were put up by small ARVN units resisting NVA troops that were now pushing south on Highway One or to those coming out of the highlands. The NVA reserve Divisions were now being moved south as rapidly as they could be deployed. When the offensive opened the NVA had about 13 Divisions in South Vietnam. By this time, it appeared all of the NVA reserves would be committed to secure a military victory. More than 19 Divisions were eventually deployed numbering some 325,000 troops.

Qui Nhon fell on the 31st of March. After the evacuation from Pleiku to Phu Cat, the 6th Air Division Commander was designated the senior military commander for that area. The A-37s at Phu Cat and Phan Rang flew an all-out effort. These two A-37 units put up the best fight of the war. Pilots in some cases loaded their own aircraft. VNAF troops fought as soldiers in defending the airfield at Phu Cat after ARVN pulled out. Targets struck by these units were so close to the airfield that pilots hardly had time to get the gear up before dropping bombs. As the area became untenable, aircraft were evacuated to Bien Hoa and Phan Rang. There is no evidence of any change in the employment of VNAF from the previous battles. With loss of the CRC at Danang, CRP at Pleiku and Ban Me Thuot, the TACS for all practical purposes was non-effective. Only the CRC at Tan Son Nhut remained but it exercised no control of strikes. There were only a few FACs left and most of the strikes were conducted without control.

The Wing Commander at Phan Rang fought on for two days after ARVN had abandoned the area. Airborne troops were sent to attempt to hold the airfield but were forced to give up. Phan Rang fell on the 16th of April. Xuan Loc would be the last line of defense.

## **G. Change in Control of Sorties**

With the loss of two MRs and the shrinking area of operations, JGS began the day-to-day allocation of sorties between the MR III and MR IV commanders. For the first time a few sorties, 20, were reserved to the TACC to use against targets of its own determination. From about April 1st through the 19th, VNAF averaged about 180 fighter sorties per day. These were allocated by JGS as follows: 100 to MR III, 60 to MR IV and 20 to the TACC. Almost all of these sorties were flown against defensive positions at Phan Rang, Phan Thiet and Xuan Loc. There is no evidence to indicate an attempt to interdict the enemy now moving as rapidly as possible bumper to bumper down coastal Highway 1. Tanks and artillery pieces were reported jammed up for miles. Again, the pattern of employment didn't change throughout the campaign.

The VNAF on its own initiative employed eight to twelve C-130s on a daily basis carrying a mixture of 55-gallon drums of oil and gas. These fire bomb loads were dropped on a corps headquarters, a suspected SA-2 site, convoys and suspected concentrations of enemy forces. During this period of 1 to 19 April, 153 C-130 bombing sorties were flown including nine 15,000 pound "daisy cutter" sorties.

## **H. Xuan Loc**

The last ditch effort in defense of Saigon was Xuan Loc. It was not the best position for defense, but if Xuan Loc fell, Bien Hoa would be indefensible with its airfield, depot and arsenal. Thus, VNAF flew more than 600 sorties in support of ARVN. As the enemy flanked Xuan Loc and came within artillery range of Bien Hoa, all operational aircraft were flown to Tan Son Nhut and Binh Thuy. In spite of the heavy anti-aircraft fire, VNAF provided effective close air support. The MR III Commander expressed satisfaction with the support given by VNAF.

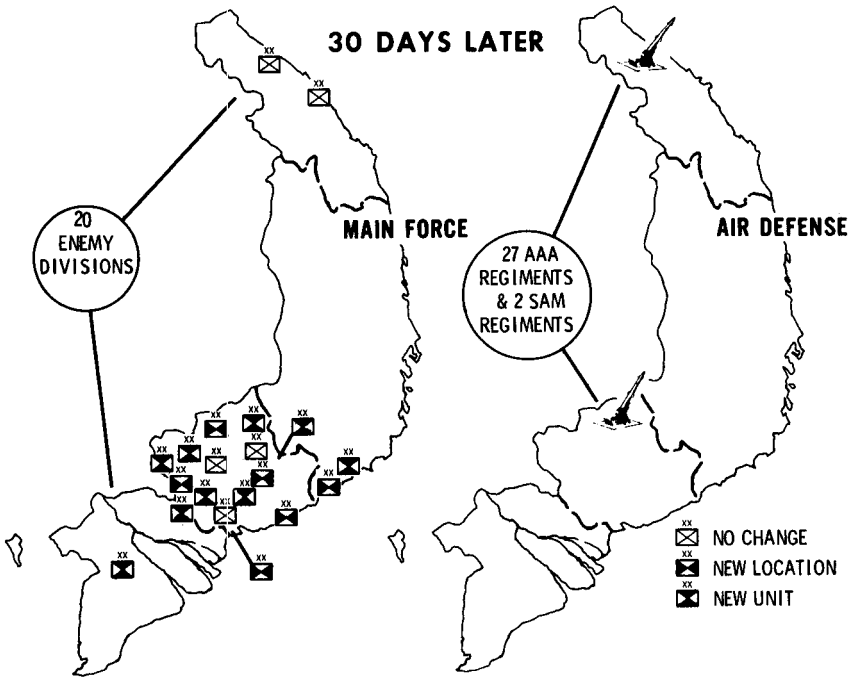

By the end of the struggle for Xuan Loc, VNAF had 1,492 aircraft, of which 976 were operationally ready, 135 redlined, and 381 lost or abandoned. The fighter force consisted of 169 A-37s and 109 F-5s. Ninety-two A-37s and 93 F-5s were operational. In spite of the evacuations, shellings and aircraft out of commission for one reason or another, the VNAF still had an operational ready fighter force of approximately 180 aircraft as compared to 392 aircraft at the time of the cease fire in January 1973.

For all practical purposes the battle was over with the loss of Xuan Loc which fell on 22 April. Saigon surrendered on the 30th. Between the 22nd and the surrender, one hundred and thirty-two aircraft were flown to U-Tapao. Twenty-six F-5s, of which 22 were E's, and 27 A-37s made it to U-Tapao.

**"Spring" Statistics 10 Mar – 10 Apr 75**

	VNAF	USAF
No. of Close Air Support Sorties .....	3,468	N/A
No. of Interdiction Sorties .....	1,349	N/A
No. of Reconnaissance Sorties .....	123	20
No. of Airlift Sorties .....	1,669	N/A
No. of Troops Moved .....	*54,000	N/A
No. of Tons of Cargo Moved .....	**4,500	N/A
Tonnage Expended .....	5,200	N/A
Combat Losses (in SVN) .....	39	N/A
No. of Aircraft Assigned .....	1,673	N/A
No. of Aircraft Left Behind .....	387	N/A
No. of Personnel .....	63,000	N/A

\* Mostly Evacuees

\*\* Presumably, Associated With the Withdrawal

## **I. Morale**

The psychological unraveling of the RVNAF precipitated by President Thieu's decision to withdraw from major portions of northern and central South Vietnam does not appear to have infected VNAF to the same degree. VNAF, in many ways, still had the potential for effective employment of its remaining forces if strong leadership had been exerted. Following the debacle in the North, they displayed courage and spirit at Phan Rang and Phu Cat. There were, however, a number of residual factors—low pay, rampant inflation, disproportionate cuts in U.S. aid to VNAF, dwindling supplies, and the fact that VNAF senior officers had little to say in strategic decisions—that contributed to the lack of VNAF initiative in the final days of the war. These factors, combined with the mood of defeatism that rapidly swept South Vietnam and its armed forces, may well have prevented the expected VNAF last stand.

### **XIII. Summary**

A. The Cooper-Church Amendment eliminated leverage in deterring North Vietnam from waging a major offensive.

B. Secure LOCs permitted North Vietnam to stock enough supplies for a 15 to 20 month campaign.

C. Lack of centralized control of the air effort fragmented and neutralized its effectiveness.

D. MR Commanders had little appreciation for the targeting of air strikes.

E. VNAF didn't have the survivability to operate continuously in a SAM environment.

F. Too many aircraft and too many different types were assigned to VNAF.

G. Helicopters had limited utility as a combat weapons systems because of SAMs and AAA, as compared to the 1968 offensive.

H. There were insufficient C-130s to provide the needed strategic mobility to offset the shortage of ARVN troops as compared to NVN strength.

I. Little planning at JGS level for integration of air and ground forces into an overall strategy.

J. Air commanders were not a daily part of the decision process at Corps/MR level on the plan of operation.

K. The heavy defenses and shortages of FACs reduced the flow of detailed intelligence and control of air strikes.

L. Strong leadership was lacking at all levels of command.

M. VNAF as a whole fought better than any other element of the RVNAF.

## **XIV. Conclusions**

A. The lack of centralized control of VNAF fragmented the employment of the force. Thus, VNAF was not used where and when it should have been to have had the most effect on the ability of the NVA to fight.

B. VNAF was designed to fight in the permissive environment of the 1968 campaign. By 1975 the enemy had produced an environment calling for the sophisticated Air Force that fought over the heartland of North Vietnam.

C. Interdiction limited the capacity of the NVA to maintain a decisive military capability in the 1968 and 1972 campaigns. With the cessation of the bombing of North Vietnam, there were no restraints on the build-up of NVA forces and logistics. As a result, they could sustain a campaign of indefinite duration in 1975.

D. There was no overall integrated planning for the conduct of the war. The Joint General Staff was not empowered to do the necessary planning for the employment of all four military regions and VNAF. Further, the JGS did not have a balanced representation of airmen throughout the staff to assure proper planning for the employment of VNAF forces.



**MONOGRAPH 5**

**Fourteen Hours at Koh Tang  
29 December 1975**

Prepared for General Louis L. Wilson, Jr.,  
Commander-in-Chief, Pacific Air Forces  
By Captain Thomas D. Des Brisay



## **Acknowledgements**

Thanks to the many USAF crewmembers participating in operations at Koh Tang who provided detailed information during the research phase for this publication.

Additionally, a special expression of gratitude to the many USAF crewmembers, units, and individuals who contributed photographs or assisted in photo preparation, and to USN personnel for photographs provided.

Finally, thanks to those crewmembers and Hq Pacific Air Forces personnel who painstakingly reviewed, edited, typed, and proofed this document.



## Foreword

The 12 May 1975 seizure of the SS *Mayaguez* and her crew by Cambodian forces and the subsequent recovery of the ship and crew by US military forces commanded public attention in the United States with an intensity which, on the surface, may have seemed out of proportion to the minor nature of the military activities involved. At the heart of the matter, of course, was not the size of the military operation but the implications of the ship's seizure with respect to US credibility and self-respect, particularly in light of previous developments in Indochina. The brazen, unprovoked seizure of the ship shocked the American public and was widely viewed as an arrogant affront—an act founded upon the belief that the United States lacked the will or ability to act decisively in even a minor incident. The US response, culminating in the recovery of the ship and her crew, captured the imagination of the American people and was greeted in the US with nearly universal acceptance and even exuberance. The United States, as a nation, had reaffirmed its will to act decisively.

That, in brief, is the substance of the *Mayaguez* affair and probably reflects the extent of coverage this relatively minor action will command in the history books. There is another story to be told, however, which history will doubtless deem of lesser significance—the assault on Koh Tang Island. Activities there were certainly not a model of military strategy for future operations. Because of unforeseen circumstances the assault on Koh Tang may have had little influence on the release of the *Mayaguez* crew and was conducted under the most disadvantageous of circumstances. Yet military activities there reveal an underlying strength which, although less tangible than the dramatic recovery of the ship and crew, is indicative of the fiber of the United States military forces. The professionalism, perseverance, and courage of American fighting men at Koh Tang was exemplified by USAF helicopter crewmembers who, despite overwhelmingly unfavorable conditions, delivered, reinforced, and then extracted some 230 marines at the island. The strong performance of US personnel at Koh Tang bodes well for the continuing potency of US military forces.

General Louis L. Wilson, Jr.  
Commander-In-Chief, PACAF



## Preface

The US military operation to recover the SS *Mayaguez* and her crew consisted of a number of related actions including the reboarding of the *Mayaguez*, air strikes against military targets on the Cambodian mainland, and insertion of US Marine Corps forces on Koh Tang Island to search for the crew of the *Mayaguez*. This monograph examines the latter action—operations relating to the insertion and recovery of Marines at Koh Tang Island.

Many US Air Force, Navy, and Marine Corps units played a role in the assault on Koh Tang. The actions of the marines, strikes by Pacific Air Forces (PACAF) aircraft, support by PACAF forward air controllers, naval gunfire, and recovery attempts by US Navy vessels were all important and deserve recognition. Yet more than anything else the insertion and extraction of some 230 US Marines was made possible by the persistent efforts of Air Force CH-53 and HH-53 helicopter crews. The focus of this report rests upon these men and their struggle against the difficult odds awaiting them at Koh Tang.

During the 14 hours Americans were on the beaches at Koh Tang, the incidents of bravery and stark drama were many. Regrettably, only a few of these could be included in a monograph such as this, whose purpose is to highlight rather than to provide a complete accounting. Yet even this modest coverage is enough to reflect an underlying dedication and professionalism which by itself, without any need for explanation or embellishment, is the real story which unfolded at Koh Tang Island.





## Table of Contents

	Page
Foreword . . . . .	87
Preface . . . . .	89
List of Illustrations . . . . .	92
Fourteen Hours at Koh Tang . . . . .	95
The Initial Assault . . . . .	100
Rescue Attempt at the Eastern Beach . . . . .	120
Completion of the First Assault Wave . . . . .	123
Recovery of the Mayaguez Crew . . . . .	131
Reinforcement and Linkup of Marines on the Western Beach . . . . .	133
Second SAR Attempt—Eastern Beach . . . . .	135
Preparations for Another SAR Attempt . . . . .	138
The Third SAR on the Eastern Beach . . . . .	143
Extraction of the Marines from the Western Beach . . . . .	146
Appendix: USAF Helicopter Crews Participating at Koh Tang . . . . .	152
Glossary . . . . .	155
Index . . . . .	156–158

## List of Illustrations

	Page
Gulf of Thailand Map .....	94
US Navy P-3 Aircraft .....	95
Route of Flight .....	96
USAF F-111; USAF AC-130 .....	97
Gunboat Underwater in Eastern Cove .....	98
Boat Sinking off the Eastern Cove .....	99
USAF HH-53; USAF CH-53s .....	100-101
USAF C-141 .....	102-103
Koh Tang Island .....	103
Northern Koh Tang Island .....	104
Aerial View of Koh Tang .....	105
Neck Separating Eastern and Western Beaches .....	106
Western Side of the Island Neck .....	107
Knife 22 Forced Down; Knife 22 Damage .....	108
Aerial View of Northern Koh Tang .....	109
Knife 32 Damage .....	110
Knife 23/31 Wreckage .....	113
Close-up of Knife 23/31 Wreckage .....	114
USAF A-7 Aircraft .....	115
USS Holt Alongside Mayaguez .....	116
Marines Board Mayaguez; Cambodian's Food Still Warm .....	117
USS Holt Towing SS Mayaguez .....	118
HC-130P Refueling a Jolly Green .....	119
Jolly Green 13 Damage (Fuel Tank) .....	121
Jolly Green 13 Damage (Close-up of Fuel Tank) .....	121
Jolly Green 13 Damage (Pilot's Instruments) .....	122
USAF F-4s .....	122-123
20mm, 40mm, 105mm Rounds .....	124
Cambodian Encampment on Koh Tang (Pre-strike) .....	125
Cambodian Encampment (Post-strike) .....	126
USS Holt .....	127
Jolly Green Helicopter Landing on the Holt .....	127
Jolly Green 41 Damage .....	128
Close-up of Jolly Green 41 Damage .....	129
Marine Reinforcements Boarding USAF Helicopters .....	130
Thai Fishing Boat Used to Return the Mayaguez Crew .....	131
USS Holt with Fishing Boat Alongside .....	132
USS Coral Sea .....	133

Jolly Green Crewmember Manning His Minigun . . . . .	135
A-7 Dispenses Riot Control Agent on Eastern Beach . . . . .	136
Wind Blows Cloud Over the Water . . . . .	137
Beached Patrol Boat (Pre-strike) . . . . .	138
Beached Patrol Boat (Post-strike) . . . . .	139
USAF OV-10 . . . . .	139
USS Wilson Blasts a Cambodian Patrol Boat . . . . .	140
Island Neck . . . . .	141
USAF Personnel Refueling a Helicopter . . . . .	142
Rescue at the Eastern Beach . . . . .	144
US Wounded Rushed to Ambulances . . . . .	150

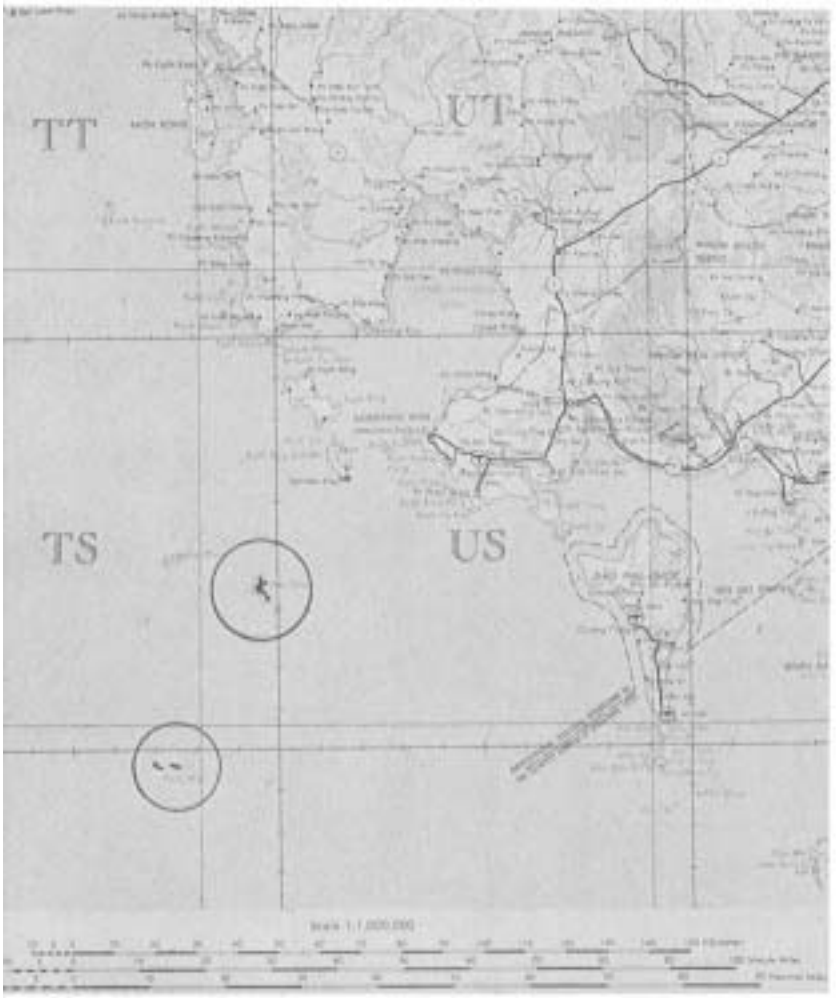

Gulf of Thailand Map showing Koh Tang and Poulo Wai Islands

## Fourteen Hours at Koh Tang

On 12 May 1975, Khmer Communist gunboats seized the SS Mayaguez in international waters in the Gulf of Thailand. The ship was captured some 60 nautical miles southwest of Cambodia near the Poulo Wai Islands (see map).

The initial US military response was limited to surveillance of the ship. In the early morning hours of 13 May, US Navy P-3 reconnaissance aircraft (see photo) spotted the vessel near Poulo Wai. Later in the morning the Mayaguez steamed to Koh Tang Island under the control of her captors.

The first Air Force aircraft called in to locate and monitor the ship were two F-111s (see photo), diverted from a training mission around noon on the 13th. The F-111s found the Mayaguez anchored about 1½ miles off the northeastern tip of Koh Tang Island. Thereafter USAF tactical aircraft monitored the Mayaguez during the day, and heavy reliance was placed on the unique surveillance capabilities of Air Force AC-130 gunships (see photo) during the hours of darkness.

When the first AC-130 arrived on the night of the 13th, Cambodian patrol boats were active in the area. Several of the gunboats were shuttling between the Mayaguez and a large cove at the northern tip of the island. The cove appeared to be the hub of activity on the island, and an encampment just inland from the cove was considered to be a likely detention place for the crew of the Mayaguez. Patrol boat activity continued during the night, and surveillance aircraft received anti-aircraft fire both from the boats and the island. The hostile fire was not returned out of concern for possible injury to the Mayaguez crew. US aircraft were, however, directed to fire warning shots across the bow of any boat departing Koh Tang and heading for the Cambodian mainland.



U.S. Navy P-3 Reconnaissance Aircraft





**USAF F-111 Aircraft**



**USAF AC-130 gunship**

In the predawn hours of the 14th, one of the patrol boats broke away from Koh Tang Island. The on-station AC-130 gunship repeatedly fired warning shots across the boat's bow, finally prompting it to run aground on a small island south of Koh Tang. In the morning, tactical aircraft took over from the gunships and continued to contain the patrol boats in the vicinity of Koh Tang. A fishing boat, however, despite repeated warning shots and riot control gas delivered by USAF tactical aircraft, succeeded in reaching the mainland. It would be verified several days later, after interviews with the Mayaguez crew, that it was this fishing boat that carried them to the Cambodian mainland initially, and subsequently to Koah Rong Sam Loem, an island just off the mainland, where they were held until their release.

During the day of the 14th, tactical aircraft sunk, beached, or damaged a number of gunboats, three of them in or near the cove at the northeastern tip of



Gunboat underwater in the cove off the eastern beach at the northern tip of Koh Tang Island.



**Koh Tang (see photos). On the night of the 14th, AC-130 gunships returned to the island and damaged or destroyed several more patrol boats.**

**Then as the night waned, after all other attempts to prompt the release of the crew had proven fruitless, US military forces were directed to seize the SS Mayaguez and to recover any crewmembers being held at Koh Tang Island.**



**Post-strike photograph of a boat sinking off the same cove. Minutes later it had disappeared in the deep water.**



USAF "Jolly Green" HH-53 rescue helicopters

## The Initial Assault

In the predawn hours on 15 May 1975, six HH-53 "Jolly Green" and five CH-53 "Knife" USAF helicopters\* (see photo) unloaded US marine boarding parties and landing forces totaling some 230 men. (The marines had been rushed to their staging base by USAF C-141s (see photo). Three of the helicopters were to deliver their men to the USS Harold E Holt, a US Navy destroyer escort, for boarding and securing the SS Mayaguez and recovering any crewmembers still onboard. The other eight choppers were to offload their marines on two beaches at the northern end of Koh Tang (see photo) to secure the island and search for any Mayaguez crewmembers who might be held there.

\* The CH-53 and HH-53 are not ordinary helicopters. They have armor plating and are equipped with 7.62mm, rapid-firing miniguns, and thus are far more survivable than most choppers. Both aircraft have external fuel tanks which extend their range. Additionally, the HH-53 rescue helicopter is air refuelable.



USAF "Knife" CH-53 Special Operations Helicopters



USAF C-141



Koh Tang Island >>

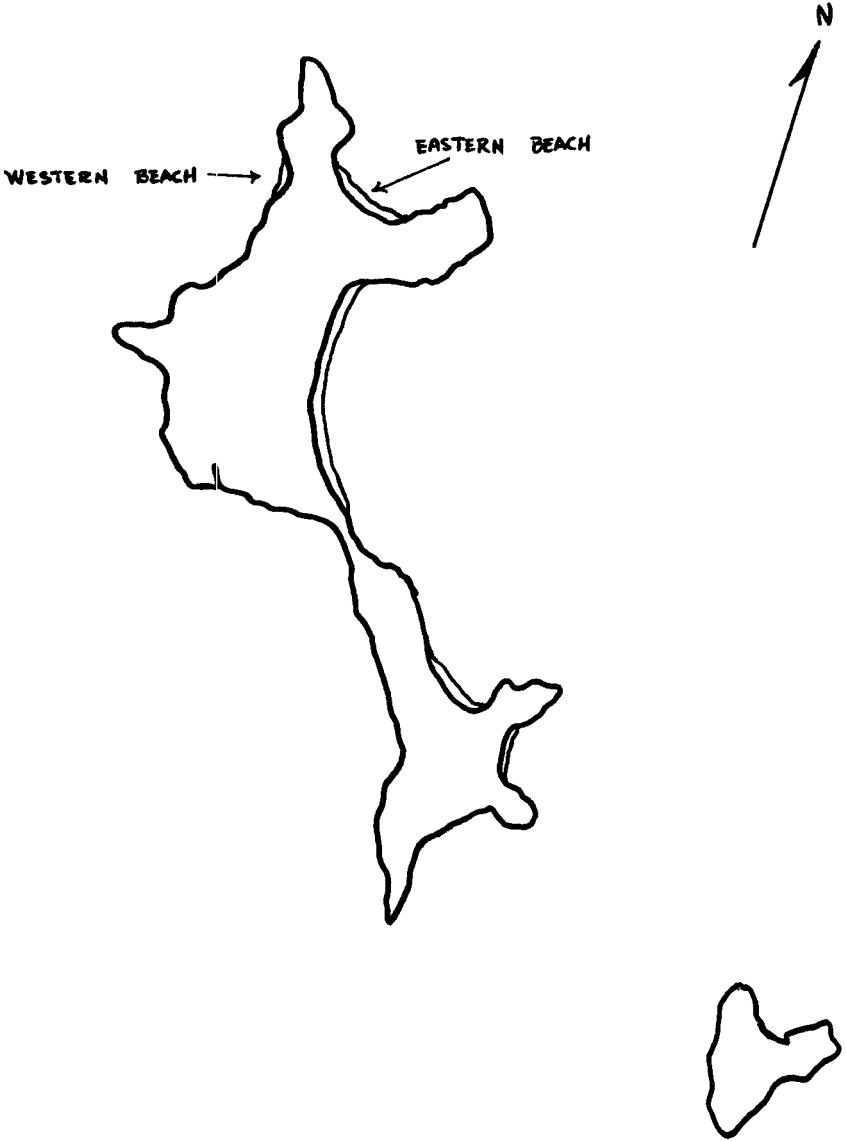

How many were being held, or even if any were held there, was unknown—there had, however, been nighttime shuttle runs by Cambodian patrol boats between the Mayaguez and the large cove at the northern tip of the island, and gunship crews observed personnel movement on the beach during the shuttling activities. Although a group of personnel was spotted aboard a fishing boat heading for the mainland on the 14th, the strong possibility that at least some crewmembers were being held on the island could not be ignored. Thus the helicopters and marines headed for Koh Tang uncertain as to the presence, number, or whereabouts of Mayaguez crewmembers.

Also unknown was the degree of enemy resistance which would be encountered, but preflight briefings based on estimates of Khmer Communist strength at the small island indicated that resistance should be low. Preparation of the landing zones with air strikes was ruled out to preclude inadvertent injury to Mayaguez crewmembers who conceivably could be in the landing zone areas. Air cover would be available overhead, however, should enemy resistance be greater than expected. Once the eight helicopters had inserted their marines they, along with the choppers flying to the USS Holt, were to return to their staging base for a second wave of marines, and again for a third wave should the extra men be required. It was a difficult scenario, and one fraught with uncertainties. These were not the circumstances a military commander would

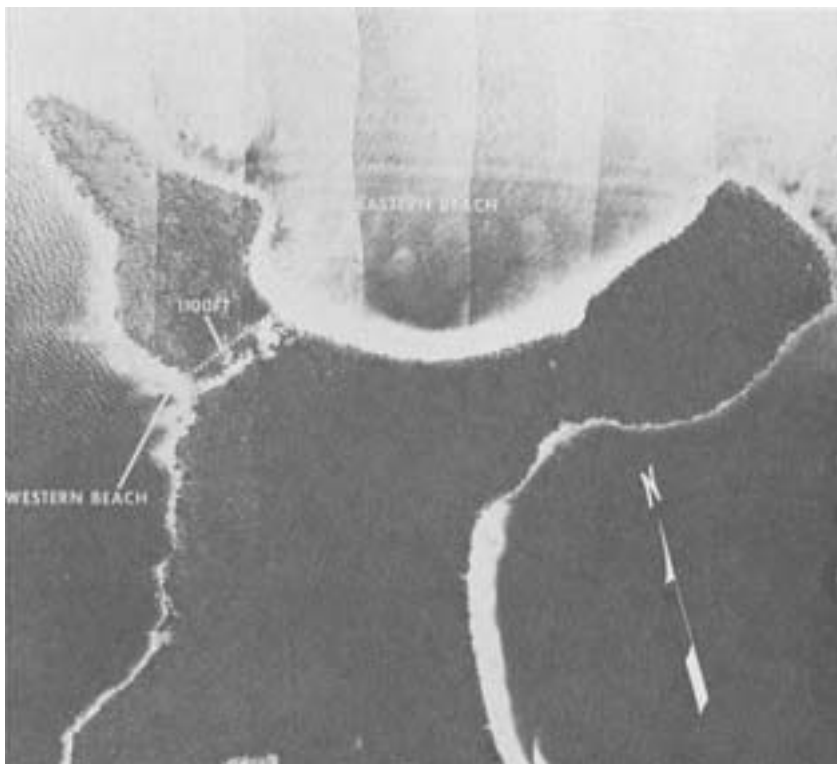

Northern Koh Tang Island

choose for such a rescue mission. There was no choice, however, but to press on under the given circumstances or forfeit the chance to recover any crewmembers who had been taken from the Mayaguez to Koh Tang Island.

As four pairs of Jollys and Knives approached Koh Tang in the darkness, little did they realize that the Mayaguez crew had been moved to an island near the Cambodian mainland. Instead of the American sailors, the enemy would be waiting—and in unexpected strength. Fortified positions, hidden in the jungle, ringed the two beaches where the choppers would land. Enemy forces, well armed with automatic weapons, rocket launchers, and mortars, put up a resistance much greater than anticipated.



USAF helicopter approaches Koh Tang from north-northwest

At first light, simultaneous insertion of marines on both sides of the island neck began (see photo). Knife 21 and Knife 22 swung down to make their approach to the small beach on the western side of the island neck (see photo). Knife 21, piloted by Lt Col John Denham, led the flight toward the shoreline and attained a hover over the landing zone on the western beach. No fire was received on the run-in and there was no sign of activity or resistance in the beach area. Then as the helicopter touched down on the beach and the marines began streaming out the back ramp, the Cambodians opened up with small arms, rockets, and mortars. To Capt Terry Ohlemeier, pilot of Knife 22, the small arms and machine gun fire *“looked like a string of Christmas tree lights”* against the dark outline of the western side of the island. Lt Col Denham, all his marines offloaded, attempted to take off from the landing zone but enemy fire had severely damaged his aircraft and disabled one of his two engines. With his wingman laying down suppressive fire, Denham managed a single-engine takeoff and headed out to sea. His crew jettisoned everything they could, but the chopper skipped over the water, maintaining barely enough power to keep from sinking. . . and taking on a little more water each time it hit. It struggled

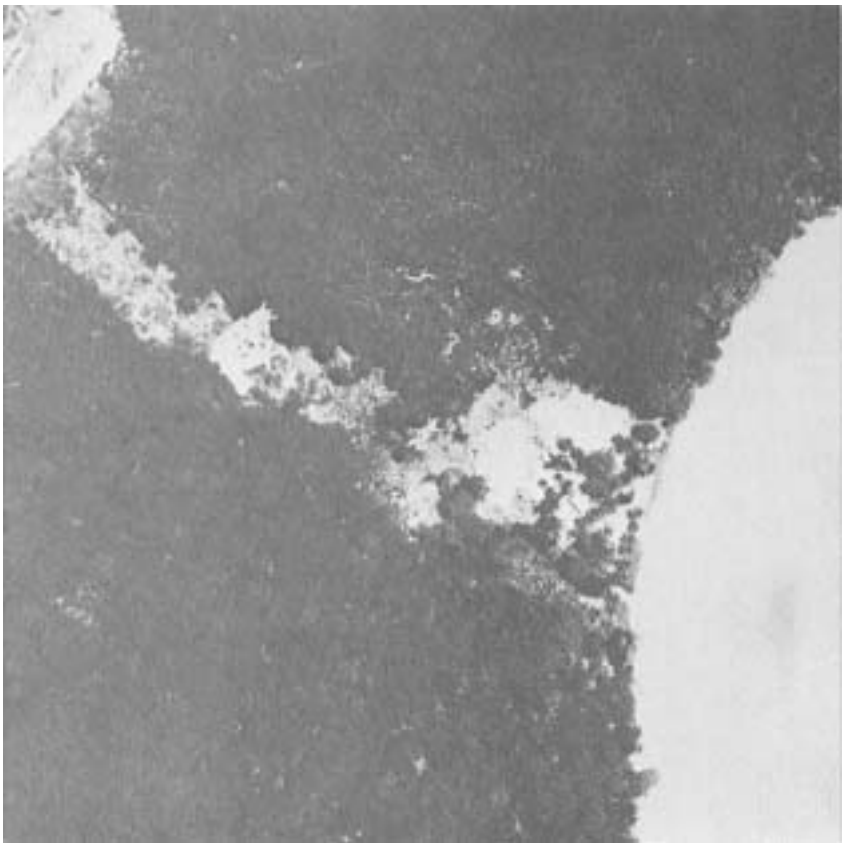

Island neck at the northern end of Koh Tang. Eastern beach is at the right, western beach is at the upper left.



nearly a mile from the landing zone before ditching in the ocean. As the crew abandoned the aircraft, SSgt Elwood Rumbaugh, the flight mechanic, pulled the copilot out of the sinking helicopter. When the copilot surfaced he had difficulty inflating his life jacket, and Denham went to assist him. Just moments later, with no call for help or indication of difficulty, SSgt Rumbaugh had disappeared; he was later officially declared killed in action.

Meanwhile a pair of fully-loaded helicopters approaching the island diverted to render assistance to Lt Col Denham and his crew, freeing Capt Ohlmeier to fly Knife 22 back into the western beach to deliver his marines. This time, however, fire was directed against the aircraft all the way into the beach,

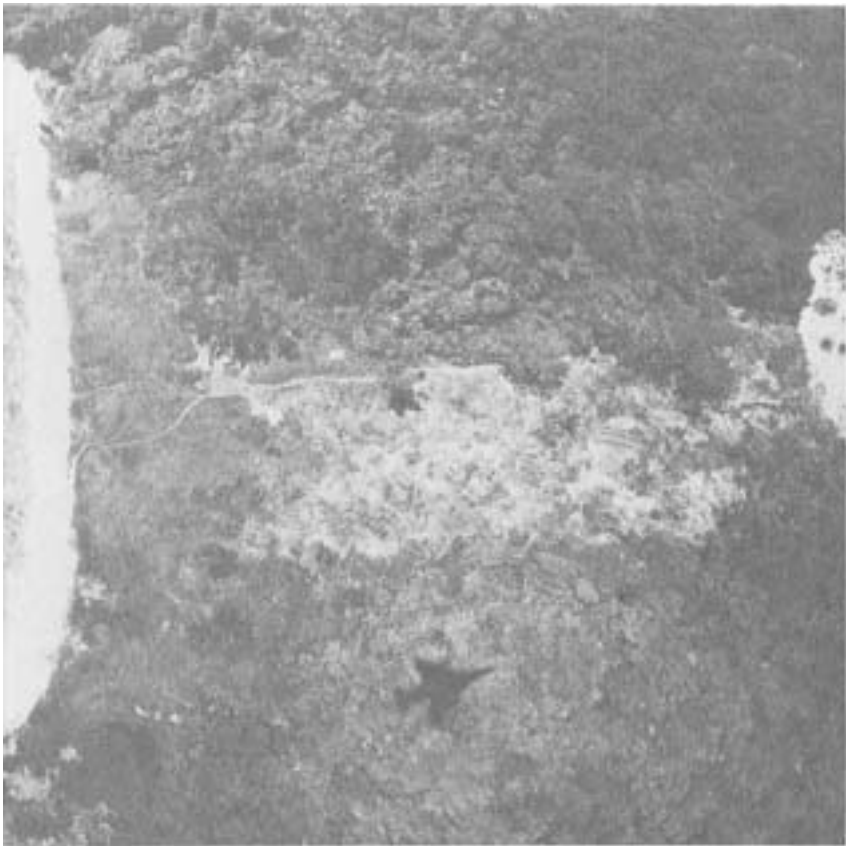

Western side of the island neck; beach is at the extreme left.

inflicting severe damage and causing an acute fuel leak. Ohlemeier, unable to insert the marines, headed back for the staging base. In the race against the fuel gauge the helicopter just made it to the mainland coast, where it was forced to make an emergency landing (see photo).

While Capt Ohlemeier had been engaged in the fruitless attempt to penetrate to the western beach, Knife 32, piloted by 1/Lt Michael Lackey, hovered near the crew of the ditched helicopter. (Jolly 41, having arrived on the scene



Knife 22 forced down on mainland coast

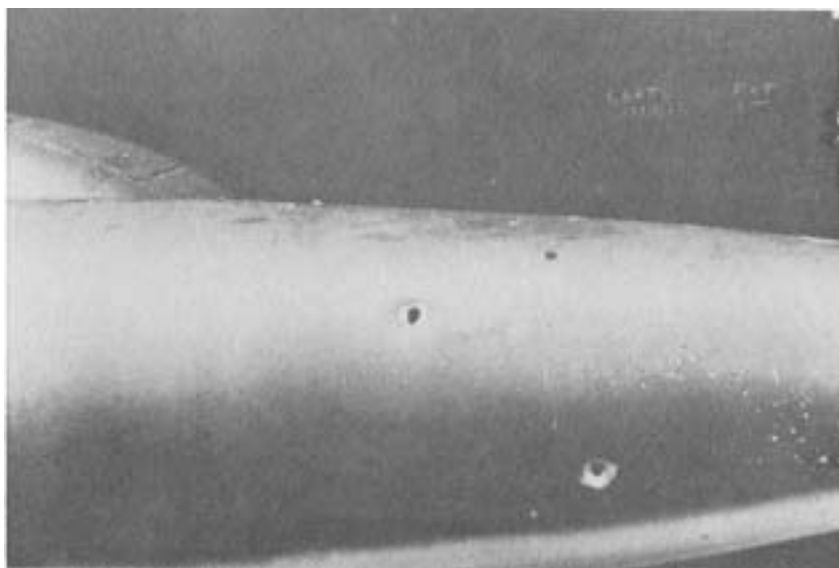

Holes in Knife 22's fuel tank

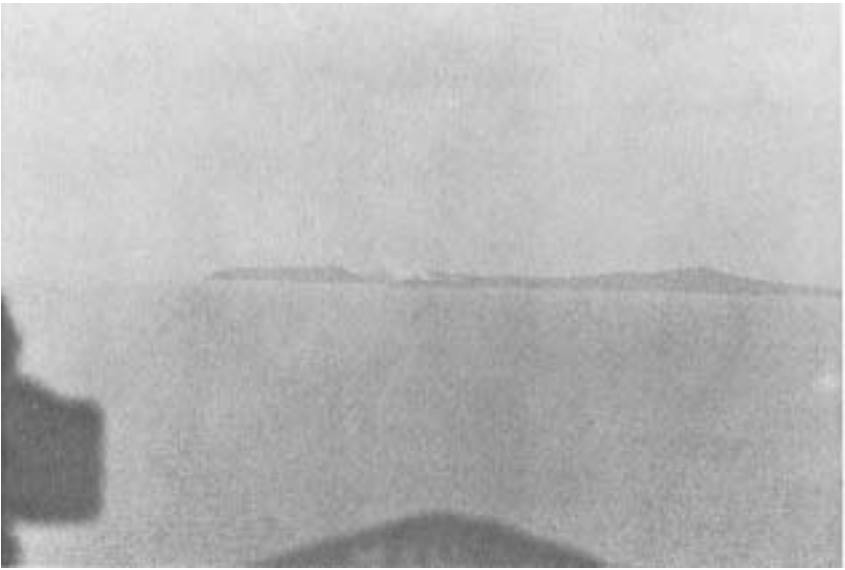

Aerial view of Koh Tang Island from the northwest. Smoke visible rising from the eastern beach.

with Knife 32, provided cover during the recovery.) Loaded with a full complement of marines and too heavy to pick up the survivors, Knife 32 began to dump fuel to lighten the aircraft. As fuel spewed from his aircraft Lackey could see a column of smoke rising from the vicinity of the eastern beach and he knew things were also going badly there (see photo). Minutes later Lt Col Denham and his two surviving crewmembers had been recovered, but the search for SSgt Rumbaugh had proven futile.

As Knife 32 then started away from the crash site and began to pick up speed, the three rescued crewmembers settled down to rest and contemplate their ordeal. Their rest was shortlived. Lt Lackey proceeded onward to the western landing zone to deliver critically needed marines. Denham and his two remaining crewmembers, just shot down and rescued, their hair and clothes soaked with jettisoned fuel, found themselves heading back to the landing zone for a second time. With heavy resistance being encountered at both beaches, reinforcements were more important than ever.

As the helicopter reached the western beach area and hovered over the landing zone, the enemy cut loose with automatic weapons, mortars, and rockets. One of the flight mechanics, SSgt Nick Morales, was immediately dropped by small arms fire as he manned one of the miniguns. Lt Lackey then touched down on the beach and the marines began to offload. Suddenly the chopper shuddered as a rocket tore a gaping hole in its side and exploded inside the passenger compartment. Incredibly, only one marine was wounded. Despite the intense enemy fire and the explosion, the dazed marines were able to deplane and Lackey managed to pull the helicopter out of the landing zone. With 75 holes in its fuselage, a leak in its hydraulic system, and extensive general

battle damage (see photo), Knife 32 withdrew as the crew immediately tended to the wounded. SSgt Morales, having sustained a collapsed lung and a severed main artery, was sinking fast. Lackey extracted every ounce of thrust from the crippled helicopter's engines and sped back to his staging base in a race against



Damage to Knife 32

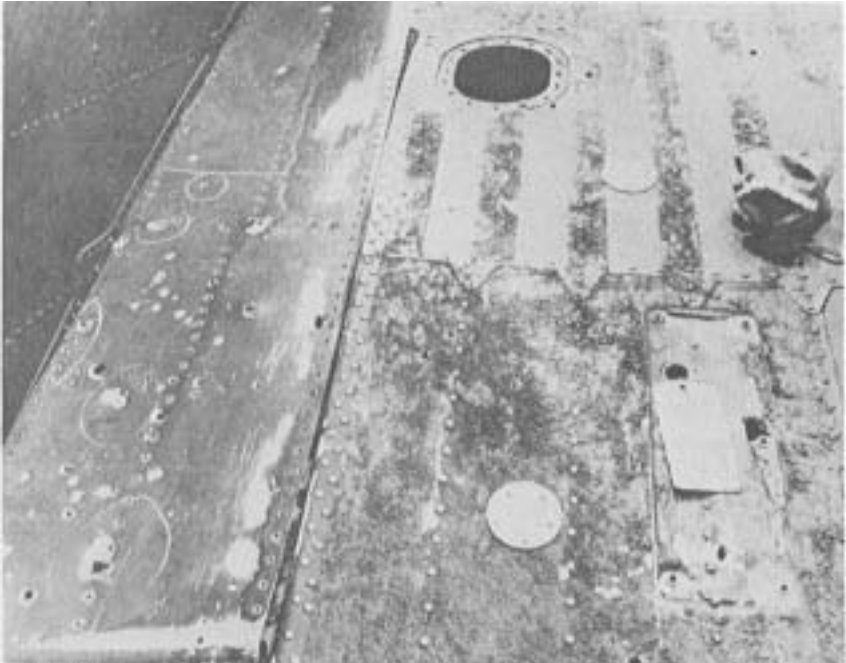

Shrapnel holes in Knife 32's sponson (Located at extreme right of previous photo)

time which he and his crew barely won. As the chopper touched down in an emergency landing at the base, only minutes of fuel were left in its tanks. Morales, scarcely alive, had even less time to spare as medical personnel rushed him to the waiting ambulance. First aid by the crew and the rapid return to the base proved just enough to save his life.

Meanwhile the situation back at the island was grim. When Denham and Ohlemeier first ran into stiff enemy fire on the western beach, Knife 23 and Knife 31 (piloted by 1/Lt John Shramm and Maj Howard Corson, respectively) approached the large beach on the eastern side of the island neck. The Cambodians surrounding the eastern beach held their fire. Then as Lt Shramm hovered above the landing zone, with Maj Corson's aircraft in trail and to the left, the enemy barrage erupted. Shramm's helicopter immediately took punishing hits, the first of which damaged the rotor system. He then saw his wingman's aircraft explode in a ball of fire; an instant later his own chopper lost an engine, shuddered from a heavy impact, and began vibrating severely. Shramm ordered the rear ramp opened and wrestled the helicopter to the beach as the entire tail section was torn off. He and two other crewmembers remained on the aircraft to shut it down, to try to establish radio contact, and to assess the situation. The copilot and an Air Force photographer, together with all 20 marines, rushed ashore. Luckily, no one was killed in the helicopter or in the dash to the treeline. The enemy was probably devoting his primary attention to Maj Corson's aircraft, which was engulfed in flames.

Corson's helicopter had been hit with a fusillade of automatic weapons, heavy-calibre machine gun fire, and possibly rockets or rocket-propelled grenades, causing it to explode in flames. He attempted to pull back to deeper water but the badly damaged aircraft would not respond. While Corson struggled to control the helicopter, Sgt Randy Hoffmaster worked over the shoreline with his minigun, and 2/Lt Richard Vandegeer, the copilot, fired his rifle out of his window. Then a direct hit in the cockpit, probably by a mortar or grenade round, blew the windshield and instrument panel away and killed Lt Vandegeer. Maj Corson, seriously injured, somehow managed to maintain control enough to settle the craft down in the water. Dazed and wounded, he stared down and saw the ocean at his feet—nothing remained of the cockpit and the instrument panel which had been in front of him. For long moments he remained in his seat. . . . stunned. Shouts from a crewmember finally brought him to his senses. As he mechanically stepped forward into the waist-deep water, flames engulfed the cockpit. One of the marines who had already exited from the aircraft braved the flames and attempted to unharness the limp body of the copilot. His hands and arms badly burned and enemy rounds impacting in the water around the helicopter, the marine was finally forced to abandon the attempt.

During the time Corson was half-conscious and still strapped in his seat, a number of passengers and crewmembers, many of them suffering from burns, had been able to exit the helicopter. One of the crewmembers, SSgt Jon Harston, found himself in the water and under fire from the shoreline. Realizing he had no rifle he reentered the burning aircraft through the passenger

door, which was just under the waterline. As he emerged inside the aircraft he saw a number of men trapped, trying to punch out windows to escape the inferno. The rear ramp was engulfed in flames and impassable, leaving the door through which he had entered as the only usable exit. He shouted to the marines to come out the passenger door, which was partially hidden by the water. Several men then followed him through the passenger door, and one or two others escaped through the hatches. Once outside, Harston worked his way to the front of the aircraft to open the emergency window for the pilot and copilot. As he got there he realized that the whole front of the cockpit was gone, and that Corson and Vandeger were still motionless in their seats. He shouted for them to get out, jarring Maj Corson to his senses. As Corson stepped through the gaping hole where the front of the cockpit had been, Harston turned his attention to the copilot in time to witness a marine's futile attempt to unstrap Vandeger, who was slumped lifelessly in his seat. Seeing there was no hope of recovering the copilot's body from the flames, Harston then swam under water to the rear of the aircraft, coming up near Sgt Hoffmaster. Harston fired his rifle and pistol until out of ammunition. Grenades were exploding around the survivors and bullets were kicking up the water everywhere.

At this point Corson, Harston, and Hoffmaster, each of whom had life preservers, began to gather the survivors around them and started away from the shallow water in three groups. During the hectic withdrawal there were many incidents of drama and bravery within each group: Sgt Harston, for example, began to withdraw to deeper water with a wounded marine. As Harston inflated his life preserver, rifle fire shot out the right bladder. At this point the two saw another wounded marine who was trying to swim toward them, but was badly burned and unable to make much progress; so, although under fire from the shoreline, they swam back to assist the disabled marine. As the three finally headed to sea to get out of range, an enemy round struck Harston in the helmet. The impact of the bullet drove him underwater, but he managed to struggle back to the surface. The three of them paddled and swam together, helping each other to the safety of the sea.

Eighteen of the 26 Americans on board Knife 31 had survived the crash and managed to exit the helicopter, but many of them were burned and dazed; all were the target of intense enemy fire as they abandoned the helicopter and struggled in the water. Able-bodied marines and crewmembers had tried to assist the more seriously wounded and disoriented and help them swim to sea to escape the deadly enemy fire. Nevertheless, four men were shot and killed, or drowned, near the burning wreckage of Knife 31. A fifth, stunned and wounded, stumbled through the water for about 100 yards to the wreckage of Knife 23 and crawled onto the tail ramp of the aircraft; he would be the subject of a futile rescue attempt later in the day. His death brought to 13 the number of men perishing in the crash of Knife 31, including 10 marines, 2 Navy corpsmen, and the USAF copilot. All 13 survivors were later picked up at sea by US naval vessels.

While the men from Knife 31 struggled to escape from the vicinity of their helicopter, the three crewmembers remaining aboard Knife 23 made a dash for

the treeline to join the rest of the crew and passengers. The last of these three men, SSgt Ronald Gross, was dropped on the beach by enemy rifle fire. He got up to his feet but another bullet knocked him to the ground. Having sustained four gunshot wounds, Gross pulled himself up and again started to run for the treeline. This time it seemed his luck had run out—Gross took an enemy round in the head. He somehow managed to continue on, stumbling to the treeline where he collapsed among his companions. The last shot had shattered his helmet but had only grazed his head. Though seriously wounded, he would survive.

Minutes after the two choppers were shot down at the eastern beach (see photos), radio contact was established with Lt Terry Tonkin, a marine forward air controller (FAC) who had been aboard Maj Corson's aircraft. Lt Tonkin, swimming to sea on his back, used a USAF survival radio to call in airstrikes on enemy positions which had fired on the survivors of the Knife 31 crash. At the same time 1/Lt John Lucas, the copilot of Knife 23, called in on his survival

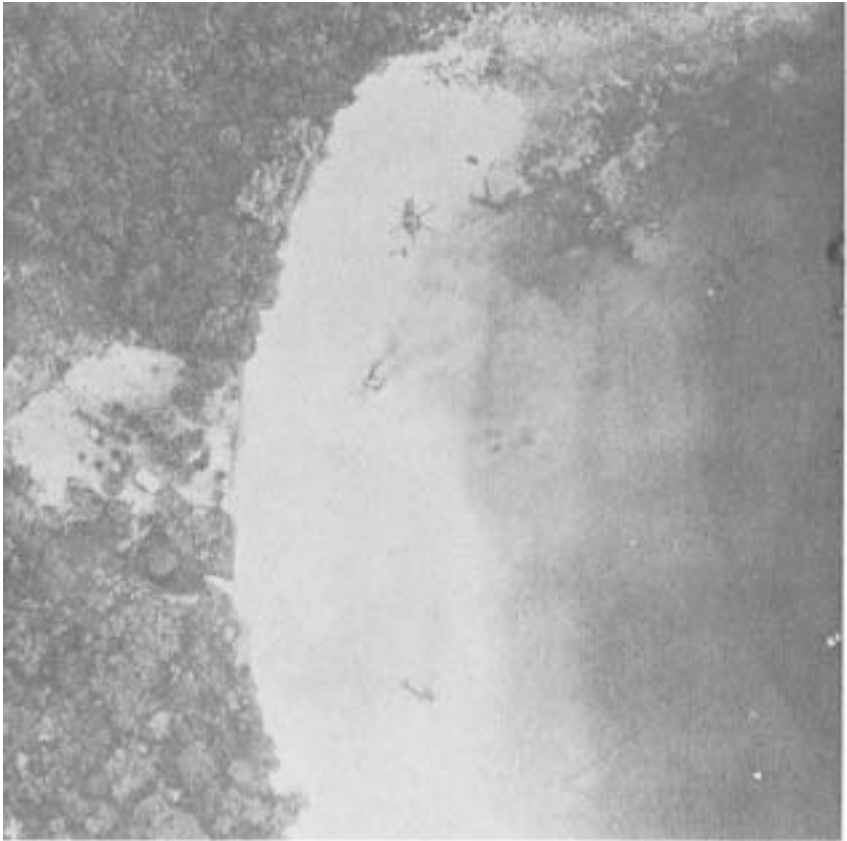

Wreckage of Knife 23 and Knife 31 (burning) on eastern beach; 1 boat beached (bottom) and 1 boat sunk in cove (extreme lower right); Cambodian encampment (middle left).

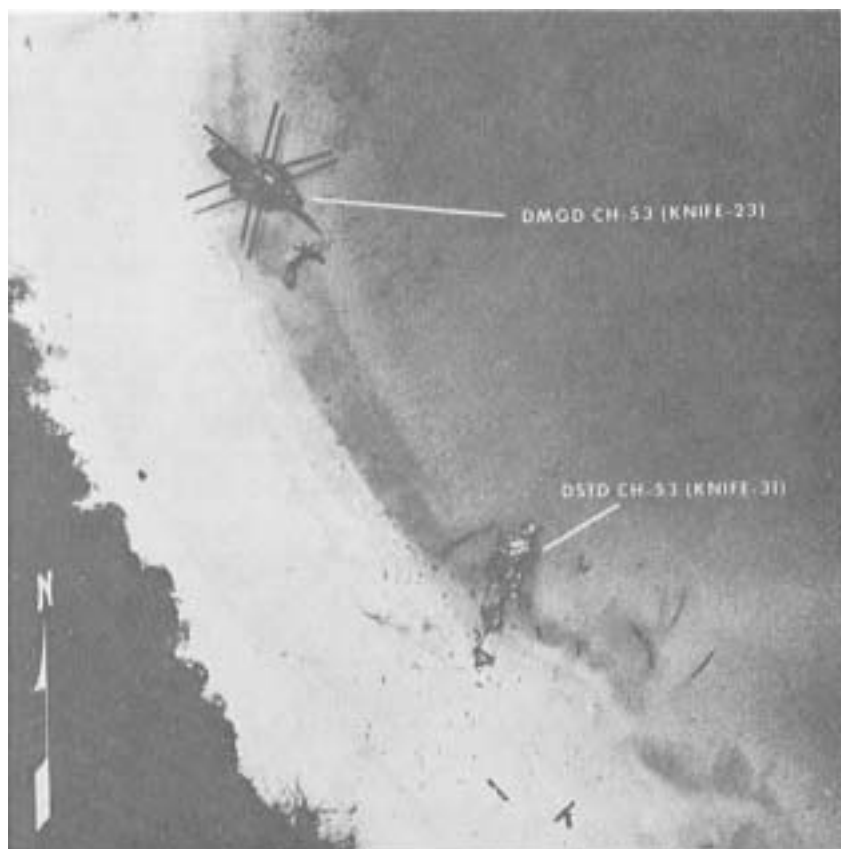

Close-up of Knife 23 and Knife 31 Wreckage





USAF A-7 Aircraft



Armed A-7s on Taxiway

radio. He was with the other airmen and marines positioned near the treeline at the northern end of the eastern beach. With guidance from Tonkin and Lucas, the USAF A-7 FAC (see photos) began to direct strafing runs on enemy positions which were still firing against the marines pinned down on the eastern beach. Once Tonkin had swum away, Lucas served as the only direct link between the marines on the eastern beach and air support, for the marines' radios had been destroyed in the crash of Knife 31.

An hour after the assault began, only 54 Americans were on the eastern and western beaches at Koh Tang Island. Fourteen others were dead. Three of the five helicopters landing at the island had been shot down, a fourth was being forced down on the mainland as a result of battle damage, and the fifth was severely damaged. Only three more helicopter insertions were scheduled in the first assault wave.

During that initial hour, a simultaneous effort had been launched to recapture the Mayaguez and recover any crewmembers who might be on board. After three Jolly Greens had delivered a marine boarding party to the USS Holt without incident, the Holt pulled up to the Mayaguez and the boarding force seized the ship—it was abandoned. The Holt then began towing the Mayaguez from the island (see photos). With the assault on Koh Tang running into stiff resistance and the whereabouts of the Mayaguez crew unknown, hope of safely and rapidly recovering the crew seemed to be fading.

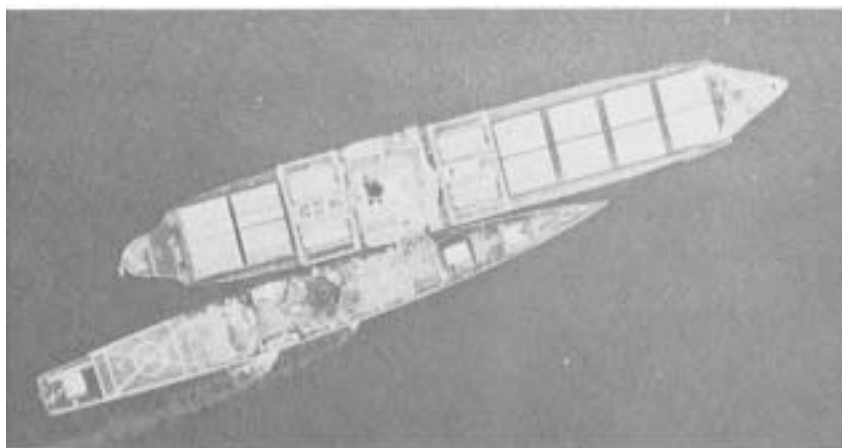

USS Holt alongside SS Mayaguez



Marine boarding party from the USS Holt seizes the SS Mayaguez



The boarding party found the Mayaguez deserted, but food hurriedly left behind by the captors was still warm



The USS Harold E. Holt tows the SS Mayaguez away from Koh Tang Island



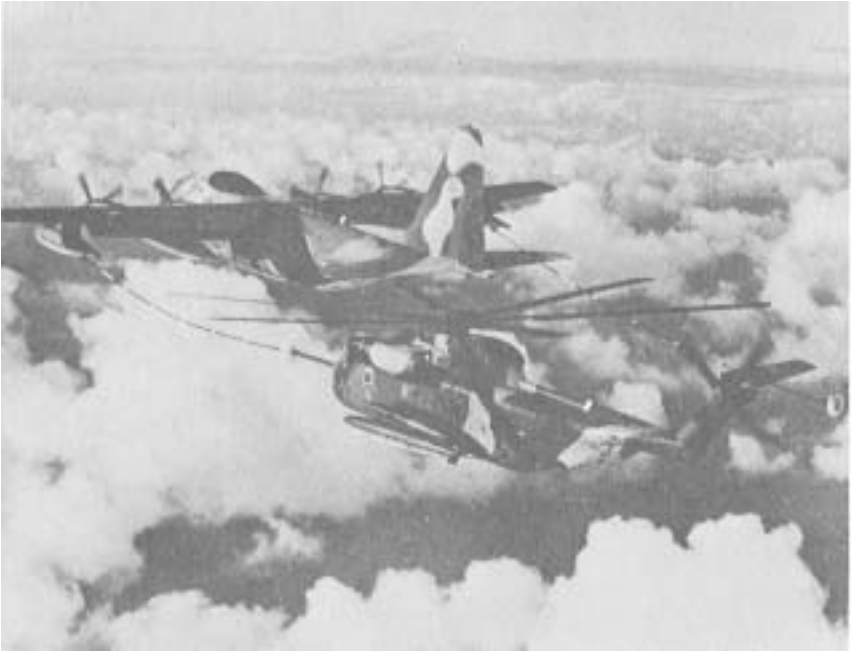

HC-130P refuels a Jolly Green

About one hour after the assault began, the last three helicopters carrying assault forces to Koh Tang prepared to deliver their marines. Considering the deadly intensity of enemy fire on the eastern beach, all three were directed to the narrow but apparently more survivable beach on the western side of the island neck. Lt Thomas Cooper, just back from air refueling at the HC-130 tanker (see photo), flew Jolly 41 into the western beach but was driven back by enemy fire after sustaining hits in the right fuel tank and ramp area. Minutes later two more Jollys attempted their insertions; Jolly Green 43 at the beach itself and Jolly 42 just south of the beach. Despite suppressive fire from their crews, both aircraft also encountered heavy resistance which forced them to abandon their first landing attempt. On the second try, the two aircraft reversed their strategies. This time Capt Roland Purser flew Jolly 43 south of the landing zone and inserted his marines at the first location available, an extremely small patch of rocks and sand some 500 to 1000 meters south of the beach. 1/Lt Philip Pacini, on the other hand, flew Jolly 42 north into the landing zone at the beach. Although the helicopter sustained extensive damage from small arms and mortar fire, the marines were successfully delivered. Jolly 42 withdrew and limped back to its staging base, escorted by Capt Purser in Jolly 43.

During the next hour, Lt Cooper made two more landing attempts with Jolly 41 at the western beach, but each time accurate automatic weapons and mortar fire prevented delivery of the troops. The marines on the beach attempted to

neutralize the enemy positions, but to no avail. Cooper returned to the tanker for a second air refueling. There were now 109 marines and 5 USAF crewmembers on Koh Tang.

## Rescue Attempt at the Eastern Beach

Following the offloading of marines at the USS Holt during the initial minutes of the operation, the three delivery helicopters had air refueled. Two of them returned to their staging base to take on the second wave of marines destined for Koh Tang. The third helicopter, Jolly Green 13, was assigned Search and Recovery (SAR) duty and orbited off Koh Tang while the A-7 FAC\* attempted to identify and destroy enemy positions. This was a time-consuming, difficult task. Time and again the A-7 flew low over the island neck, trying to draw enemy fire and thereby pinpoint the well-hidden enemy positions. The Cambodians refused to fire during these passes but came up again as soon as the A-7 finished each pass. Further complicating matters there were three factors which dictated extreme caution in the delivery of ordnance and limited initial strikes to 20 mm cannon fire: (1) uncertainty as to the exact location of all friendlies on the eastern beach (i.e., some of the personnel could conceivably have made it to the treeline without radios), (2) the close proximity of the enemy to friendly positions (as close as 20 meters), and (3) the presence of friendly forces on the western side of the island neck (the width of the neck was only 400 meters from beach to beach, and marines had pushed inland from the western beach for an unspecified distance.) Despite the difficult situation and the certainty of heavy enemy fire, the pilot and crew of Jolly 13 willingly flew into the eastern beach for a SAR attempt. They did this fully aware that the enemy could be using the 25 Americans on the eastern beach as bait to draw more helicopters into the crossfire.

Shortly after 8 am 1/Lt Charles Greer, pilot of Jolly 13, began his approach. Heavy ground fire was observed early in the run-in and continued all the way into the landing zone, which was a short distance north-northwest of the wreckage of Knife 23. Disregarding the thud of rounds smashing into his aircraft, Lt Greer touched down on the beach while his crew raked the shoreline with their miniguns. Cambodian positions, however, were numerous. The survivors, although in sight of the rescue helicopter, were pinned down by heavy fire. In what was a matter of seconds, but must have seemed much longer, Jolly 13 remained in its exposed position, absorbing punishing hits from heavy automatic weapons. Then two fires broke out—one in the Jolly's flare case and another in its auxiliary fuel tank. It looked as though the wreckage of a third helicopter would litter the eastern beach. With all hope of recovering the men at the treeline lost and his aircraft engulfed in flames, Greer

---

\* USAF A-7 FAC/strike aircraft shuttled between the refueling tanker and the island to maintain continuous FAC coverage throughout most of the day. Except for several intervals during which AC-130 gunships assumed the FAC role, A-7s directed air support activities at the island for approximately a 10-hour period. They were relieved by OV-10 FACs at about 4 pm, local time.

pulled back from the landing zone. A quick-thinking crewmember jettisoned the burning flare box, while the rest of the crew disregarded the intense heat and continued to return enemy fire. Minutes later, as the helicopter picked up speed, the fire in the auxiliary fuel tank blew out. Greer nursed his chopper away from Koh Tang and limped back toward the mainland with 35 holes, severe rotor blade damage, and fuel, oil, and hydraulic leaks (see photos).

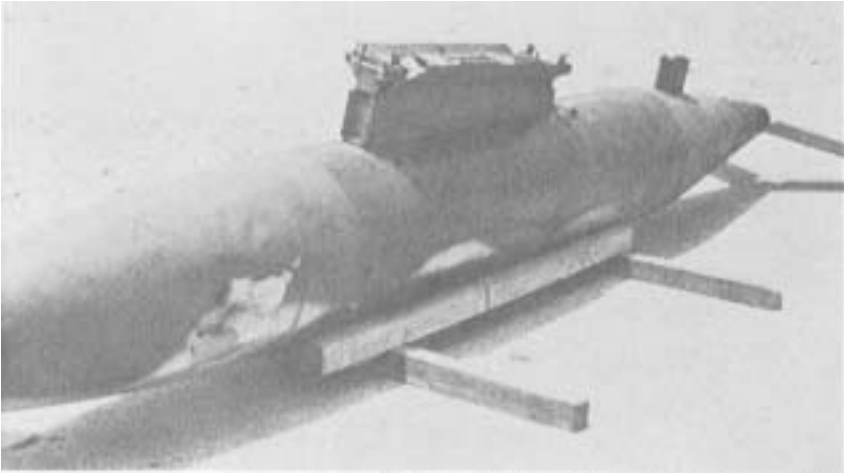

Hole in Jolly Green 13's fuel tank.

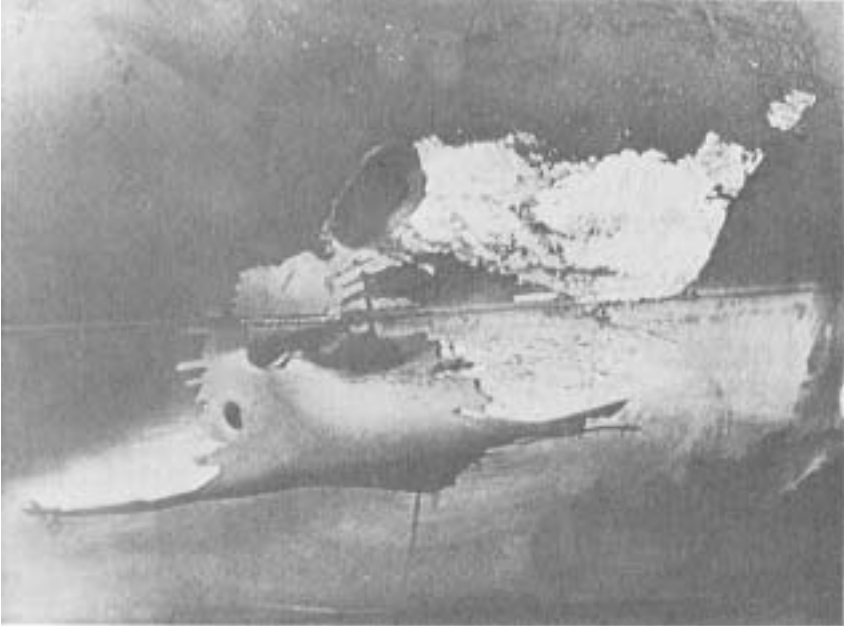

Close-up of severe damage to Jolly Green 13's fuel tank

After the departure of Jolly 13, A-7 aircraft rocketed and strafed enemy positions which had been active during the SAR, including a number of structures in the clearing just inland from the center of the eastern beach. Next, USAF F-4s (see photo) bombed the enemy emplacements, and still later a Spectre (AC-130) gunship fired on them again (see photo).



Jolly Green 13 pilot glanced down and saw an enemy round aimed at him, lodged in his shattered screen. The bullet had penetrated the windshield and instruments but spent itself just as it was about to break through.



USAF F-4





USAF F-4

## Completion of First Assault Wave

As USAF aircraft pounded enemy positions on the eastern side of the island neck, Lt Cooper and his crew returned from the tanker for another delivery attempt at the western beach. He held Jolly 41 in an orbit off the island while the A-7 FAC tried to pinpoint combatant locations on the western side of the neck so that suppression of enemy fire would be possible. The fluid and confusing battlefield situation, however, together with the lack of marking smoke at the northern location, prevented the immediate application of air support.

The marines on the western side of the island were in two groups: 60 were in the vicinity of the beach, and 29, including Lt Col Randall Austin, the commander of the ground forces, were in a separate enclave on the shoreline some 500 to 1000 meters south of the beach. An element from the beach had attempted to push south to reach the smaller group but had immediately encountered heavy enemy resistance, including automatic weapons fire and strategically emplaced claymore mines. One marine was killed and a number seriously wounded in the attempt. At that point the southern marine group began slowly working its way north along the shoreline. It soon became apparent that fortified positions, including bunkers, huts, and entrenched Cambodian forces, lay between the two marine groups and prevented linkup. These same fortifications were positioned to direct accurate fire against the western beach, hampering helicopter insertions.

Finally a Spectre gunship was able to locate all friendly forces and began to direct 20mm and 40mm fire against the enemy gun positions between the two marine units. These strikes at times came well within 50 meters of friendly forces, but the deliberate expenditure of ordnance prevented any accidents.

With the Spectre still putting down suppressive fire, Lt Cooper and his crew began another run-in to the western beach. Notwithstanding the air cover, Jolly Green 41 continued to receive accurate rounds from between the marine positions at the location being struck by the gunship, thus suggesting that enemy forces there were in covered fortifications. Cooper's aircraft, having

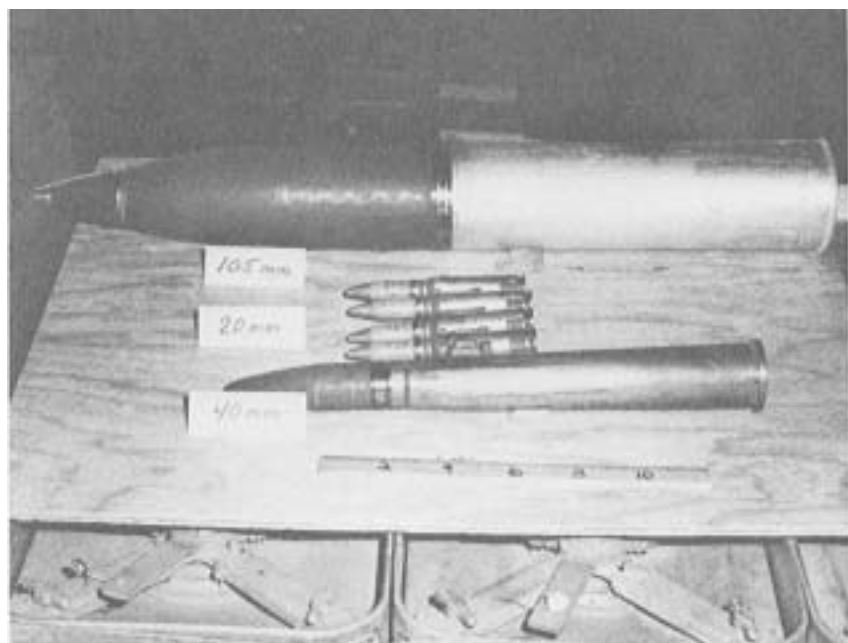

taken hits in the engine cowling and main rotor blades, was forced to terminate its hover and withdraw. The southern element of marines then notified Spectre that they had seen the fire emanating from a complex of huts and bunkers just north of their position. With corrective guidance from the marines, Spectre then laid down 105mm rounds, its heaviest ordnance (see photo), scoring direct hits and reducing the fortified complex to rubble.



Enemy encampment off the eastern beach at the northern end of Koh Tang Island

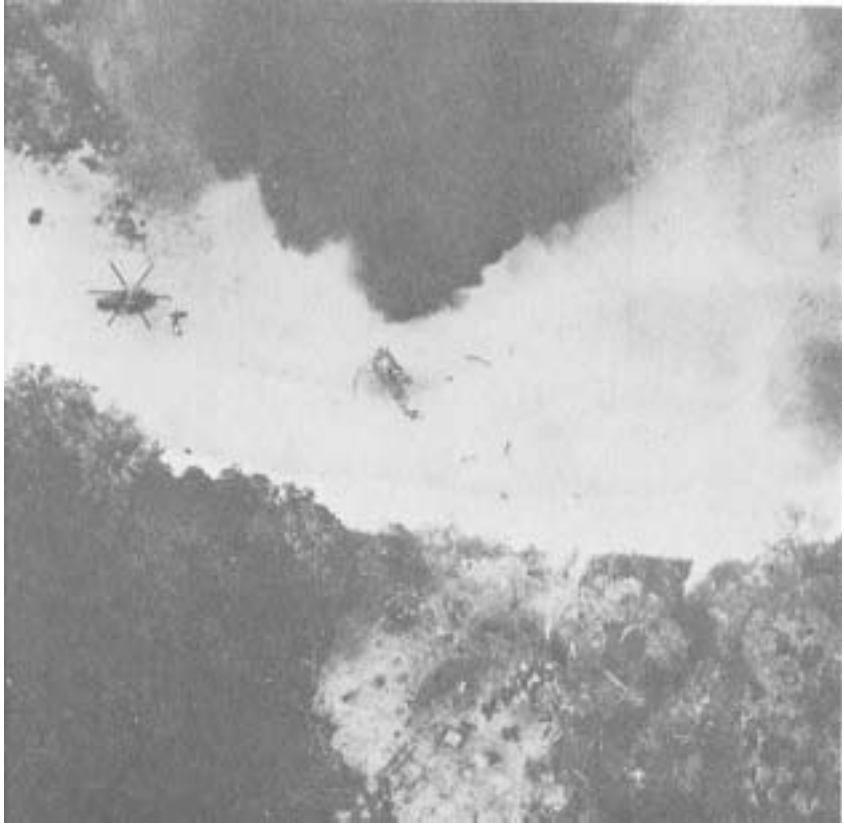

Post-strike photograph taken after A-7s, F-4s, and an AC-130 struck the enemy encampment.

With both the Spectre gunship and Jolly 41 low on fuel, Cooper flew into the western beach for the fifth time. Spectre continued to bombard the area between the marine positions, and enemy small arms and automatic weapons fire was light. As the marines poured out of the helicopter, however, a new threat emerged; mortar rounds began dropping into the landing zone. As the enemy mortar squad zeroed in, each round came closer to the mark—the sixth landed only 10 feet from the tail rotor. With all but five marines offloaded, Cooper temporarily aborted the insertion and lifted off from the beach. Moments later he came into a hover over the landing zone. As the helicopter touched down to deliver the remaining five marines a mortar round passed through the rotor



USS Holt and crew stand by as a Jolly Green approaches



Jolly 11 watches as his wingman lands to deliver Marines

blades, landing within 20 feet of the personnel door and spraying shrapnel against the aircraft. Lt Cooper once again aborted the insertion. As the helicopter attained a hover and began to pull back, a mortar round exploded on the beach where the chopper had just been sitting, blowing a hole in the aircraft's belly (see photos) and causing shrapnel damage to the underside of the cargo ramp. Cooper, with five marines still onboard, withdrew to refuel and was directed back to his staging base to assess battle damage and, if possible, to onload more marines for another delivery to Koh Tang. The helicopter finally reached its staging base some 8 hours after it had departed. Extensive battle damage prevented it from relaunching during the remainder of the operation.

With the departure of Cooper and his crew, the initial insertion phase at Koh Tang was over. A total of 131 marines and 5 USAF crewmembers had been delivered to Koh Tang, but losses and damage were heavy. Fifteen Americans had been killed in action. Further, eight of the nine\* helicopters hitting the beaches at Koh Tang had either been shot down or damaged so severely they could no longer be employed in the operation. The ninth helicopter, Jolly 43, had returned to the staging base with Jolly 11 and Jolly 12 (both of which

---

\* Eight helicopters flew directly to Koh Tang, one more first flew to the Holt and then conducted a SAR mission at the island, and two others flew to the Holt thence to their staging base for more marines. Thus, while a total of 11 helicopters participated in the assault phase, only nine of them touched down at Koh Tang Island itself.

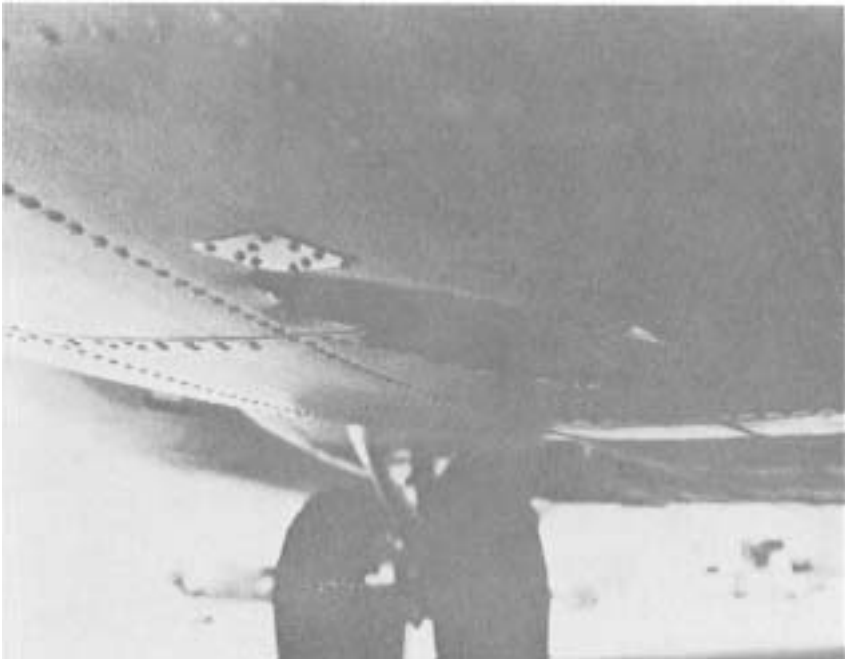

Battle damage to underside of Jolly 41



Close-up of hole in Jolly 41 belly.

had delivered boarding parties to the USS Holt) to prepare for delivery of marine reinforcements to the island (see photos). These three aircraft were joined by two more helicopters, Knife 51 and Knife 52, which had been non-operational during the initial assault but had been subsequently repaired.



Marine reinforcements bound for Koh Tang board a CH-53 "Knife" helicopter





## Recovery of the Mayaguez Crew

Some three hours after the first marines were on the beach at Koh Tang, and while Lt Cooper was still involved in unsuccessful attempts to get into the western beach with the last load of marines in the assault phase, a Thai fishing boat (see photo) flying a white flag was seen approaching the island from the direction of the Cambodian mainland. Approximately 1 hour later the boat had been intercepted and the passengers, the entire Mayaguez crew, were safely aboard the USS Henry B. Wilson. The crew was soon transferred to the Mayaguez, which then steamed away from the Koh Tang area under its own power.

In retrospect, on the basis of interviews of the Mayaguez crew, it appears the Cambodians were considering release of the crew on the night of the 14th but at the last minute changed their minds. The crew was then told a decision would be reached by the morning of the 15th. The containment and destruction of Cambodian gunboats must surely have been a factor in the final decision to free the crew, but whether or not the assault on Koh Tang also helped prompt their release is subject to speculation. (It is true, however, that the crew did not actually depart their island of captivity until more than an hour after the assault had begun.) Whenever the decision was made to release the crew, however, it was not communicated to the United States; the fate of the crewmembers remained a mystery up to the moment they approached and were taken aboard the USS Wilson.

With the successful recovery of the crew, the focus of the operation shifted



Thai fishing boat which carried the MAYAGUEZ crew to freedom later, ties up along side the USS HOLT. It was this same boat that transported the crew from Koh Tang Island to Kaoh Rong Sam Loem Island on the 14th.



Overhead view of Thai fishing boat alongside the USS Holt.

to withdrawal of US forces from Koh Tang. Yet before the marines could be withdrawn reinforcements were mandatory to stabilize the situation on the island. The 131 marines and 5 USAF crewmembers on Koh Tang were under heavy fire and were split into three separate groups which were unable to link up—82 were on the western beach, 29 were located south of that beach, and the remaining 25 were isolated across the island neck at the eastern beach. Efforts to extract the latter group had thus far proven costly and futile. Only five helicopters remained to deliver reinforcements and to subsequently extract the entire American force from the beaches of Koh Tang. All five choppers were already loaded and enroute to the island. Along with the seemingly overwhelming difficulties facing the operation, however, were two positive factors. First, the naval aircraft carrier USS Coral Sea (see photo) was steaming for Koh Tang and by afternoon would be close enough to serve as nearby offloading platform once the decision to withdraw had been made. This would, in effect, multiply the extraction capabilities of the five participating helicopters. Second, with the entire crew of the Mayaguez recovered, air cover could be supplied at the island without fear for their safety.



USS Coral Sea

## **Reinforcement and Linkup of Marines on the Western Beach**

While the five helicopters were making for Koh Tang with reinforcements, Lt Col Austin's group of 29 men fought its way north along the shoreline but bogged down at a position within earshot of the western beach. The area just south of the beach and inland from the treeline was still infested with enemy

squads which were in a position to direct accurate fire against incoming helicopters.

Shortly before noon the delivery of marines began. Knife 52, low on fuel, made the first insertion attempt. Lt Robert Rakitis brazenly approached the eastern beach at high speed for a quick insertion. His aircraft immediately took hits, prompting him to abort the attempt and fly straight over the island neck from east to west. With holes in his fuel tanks and lacking a refueling capability, Lt Rakitis was forced to cease delivery attempts and return to the mainland. The remaining four helicopters made their run-ins to the western beach in two pairs.

1/Lt Richard Brims (Knife 51) and Capt Roland Purser (Jolly 43) punched into the western beach, their crews directing nearly continuous minigun fire at enemy gun flashes as close as 50 yards from the helicopter. Despite incoming mortar rounds and substantial small arms and automatic weapons fire, both helicopters were able to deliver their marines. Lt Brims, first into the landing zone, evacuated five wounded marines and withdrew with only minor damage to his helicopter. While his crew feverishly administered medical treatment, Brims departed for the staging base to deliver the critically injured. Capt Purser, having delivered his marines without any known battle damage, left for the HC-130 tanker and subsequently returned to the island for a SAR attempt on the eastern beach.

As soon as Brims and Purser had pulled out of the western beach the last pair of helicopters began their run-ins. 1/Lt Donald Backlund (Jolly 11), first into the narrow beach, jinked his aircraft around to put the tail ramp on the shore, a maneuver which all of the reinforcement helicopters had been forced to make because of the rocky, steeply sloping beach and the rising tide. Capt Paul Jacobs (Jolly 12) hovered offshore so his crew could provide suppression with their miniguns, but enemy ground fire could not be returned at that time due to the presence of marines in the line of fire. After Lt Backlund's full load of marines rushed ashore, he pulled back from the beach to provide cover for Capt Jacobs.

It was approximately at this time, while reinforcements were being offloaded, that the southern group of marines finally reached the beach area and linked up with the main assault force. Having fought their way past one enemy position after another, they brought with them one captured 60mm mortar (they had seen another but did not capture it), one 57mm recoilless rifle, and numerous M-16 and AK-47 rifles.

As the last marines were offloading from Jolly 12, Capt Jacobs received a radio call from the ground commander requesting evacuation of more critically wounded men. Jacobs held his chopper on the exposed beach while the casualties were brought out and his crew took the injured on board. Meanwhile Backlund's crew suppressed intermittent small arms fire with their miniguns and automatic weapons. During the delivery of marines and evacuation of wounded, hits were taken by both aircraft but no substantive damage was apparent. Jacobs then sped back to the staging base with his crew administering emergency medical aid to the wounded. At the same time, Backlund and

crew departed the beach area to air refuel and join Capt Purser for SAR duties at the island.

It was just after noon when the delivery of reinforcements was completed. Some 222 Americans were on Koh Tang Island, nearly all of them concentrated near the small beach on the western side of the island neck. Marines on the western side had linked up and were now strong enough to consolidate their position. Enemy forces, however, were still positioned in strength throughout the island neck area—it was clear that any attempt by the marines to push across the neck to the eastern beach would result in heavy casualties. Recovery of the men stranded on the eastern beach would have to be accomplished by helicopter. Only four operational helicopters were left. Two were racing to their staging base with wounded marines and the other two were making ready for a second recovery attempt on the eastern beach.

## Second SAR Attempt—Eastern Beach

When Capt Purser (Jolly 43) and Lt Backlund (Jolly 11) returned to Koh Tang from refueling, USAF jets and naval artillery were working over the area surrounding the 25 men on the northern tip of the eastern beach. The helicopters orbited off the island, biding their time while the strikes continued. Finally, at about 2:30 in the afternoon, the SAR attempt was launched. Preceded by an A-7 dispensing riot control agent (see photo), Purser's chopper led the way into the landing zone. Backlund and his crew were right behind to provide suppressive minigun fire throughout the recovery. During the run-in Pur-



USAF crewmember suppresses enemy resistance with his aft minigun as Jolly Green 11 participates in the reinforcement of Marines at the western beach

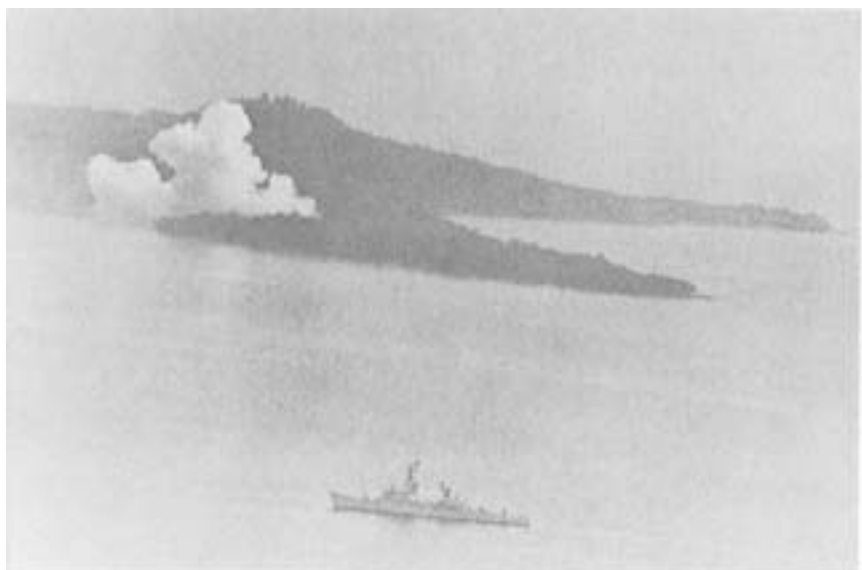

Riot control agent dispensed by A-7s in an attempt to recover the Americans stranded on the eastern beach



ser and his men could see that the riot agent would be of no assistance—the wind had blown it over the water. To make matters worse one of the miniguns jammed, leaving the left side of the aircraft virtually defenseless. Aware of the increasingly precarious position of the men on the beach, however, Capt Purser and his crew were not about to abandon their run-in. As the rescue helicopter attained a hover over the beach, intense and accurate small arms, automatic weapons, and mortar fire shot out one of the aircraft's two engines and ruptured a fuel line; raw fuel began spraying into the cabin. Seeing his comrades in trouble, copilot 1/Lt Gary Weikel turned Jolly 11's white belly up to draw away enemy fire. Meanwhile, Sgt Thomas Bateson, manning Jolly 43's ramp minigun, was felled by mortar fragments, and the aircraft's only other operable minigun jammed. With his crew shutting down the disabled engine and struggling to stem the massive fuel leak, Capt Purser managed to nurse the aircraft out of the landing zone on one engine. He withdrew from the cove area under cover fire provided by Lt Backlund's crew. By this time the USS Coral Sea had approached to within some 70 miles of Koh Tang and Purser elected to recover there. Escorted by Lt Backlund, Purser made a single-engine landing on the Coral Sea. His flight mechanic, TSgt Billy Willingham, and Coral Sea maintenance personnel immediately initiated repairs. Capt Purser and his crew were anxious to return to the island and later would do just that.

Following the abortive rescue attempt, however, Jolly 11, Jolly 12, and Knife 51 were the only helicopters still operational. A fourth, Jolly 44, had been out of commission at its staging base but then became operational after undergoing intensive repair efforts. Extraction of ground forces before the arrival of darkness was viewed as critical, but the prerequisite to that, recovery



As Jolly Green 43 approaches the eastern beach, wind blows the cloud over the water

of the men trapped on the eastern beach, was proving impossible—only four Air Force helicopters were still on hand to conduct the operation.

## Preparations for Another SAR Attempt

By late afternoon ground fire on Koh Tang had not abated. Air Force aircraft continued to single out and destroy enemy positions but many well-hidden fortifications remained. One crucial position, however, had just been discovered during the last SAR attempt and would soon be removed—a seemingly deserted patrol boat run aground and abandoned on a reef in the water off the eastern beach (see photo). Following Capt Purser's departure from the landing zone, Lt Lucas radioed an urgent message to the A-7 FAC from the Americans dug in at the treeline on the eastern beach; fire had been seen coming from the deck of the patrol boat during the last SAR. Enemy soldiers, apparently hiding under the deck, would come up and fire their heavy automatic weapon only when the helicopters approached the beach. Everyone had focused attention on the heavy fire emanating along the length of, and inland from, the treeline. Activity on the boat in the cove had gone unnoticed, resulting in a deadly cross-fire which had been unopposed during previous recovery attempts. To remedy the situation A-7s rolled in and repeatedly strafed the grounded patrol boat. Although badly mauled and apparently deserted, the beached boat was still



Pre-strike photograph of beached patrol boat.



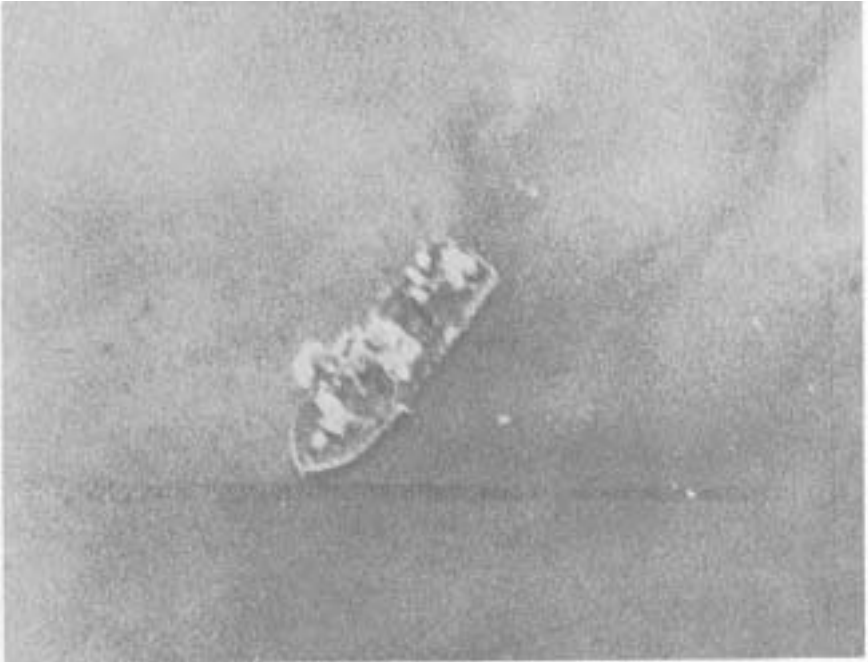
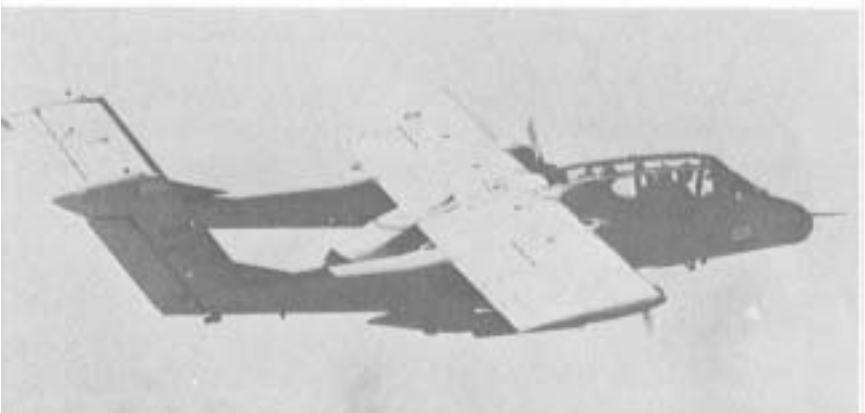

Photo of beached patrol boat after being strafed by A-7s.

menacingly intact (see photo). The USS Wilson volunteered to destroy it with artillery fire.

At that time, about 4:00 in the afternoon, two OV-10 “Nail” FACs (see photo) arrived at the scene to relieve the A-7 FACs. The OV-10 and A-7 FACs agreed that the threat from the gunboat should be completely eliminated. As soon as the OV-10s assumed control the USS Wilson commenced shelling



USAF OV-10 aircraft



The USS Wilson directs fire against a Cambodian patrol boat aground on the eastern beach as a USAF Jolly Green helicopter looks on.

the beached gunboat (see photo). That ounce of prevention proved immensely wise—as gunners from the Wilson zeroed in on the boat a half dozen enemy soldiers scrambled to the deck to escape. In the next instant a direct hit obliterated the boat and its crew, touching off a series of secondary explosions and producing a towering column of dense smoke. A primary threat had been eliminated.

During the previous recovery attempt, heavy enemy fire had also been seen coming from the cleared encampment area inland from the middle of the eastern beach. Although the area had been bombed repeatedly, Maj Undorf, the low FAC\*, could still see structures there on his low, slow passes over the island neck. Several buildings had indeed been destroyed; others, partially obscured by vegetation, were still intact. Personnel movement was visible throughout the area. The buildings had to go, but first the forward positions of marines penetrating across the neck from the western beach would have to be fixed. Flying dangerously low over the island neck, the Nail FAC spotted personnel in foxholes and laid a marking rocket down as a point of reference to

---

\* The Nails worked in pairs, one high (managing and briefing incoming strike aircraft) and one low (directing strikes and maintaining close surveillance of the battlefield). Maj Robert Undorf was the low Nail, Capt Richard Roehrkasse was the high Nail.

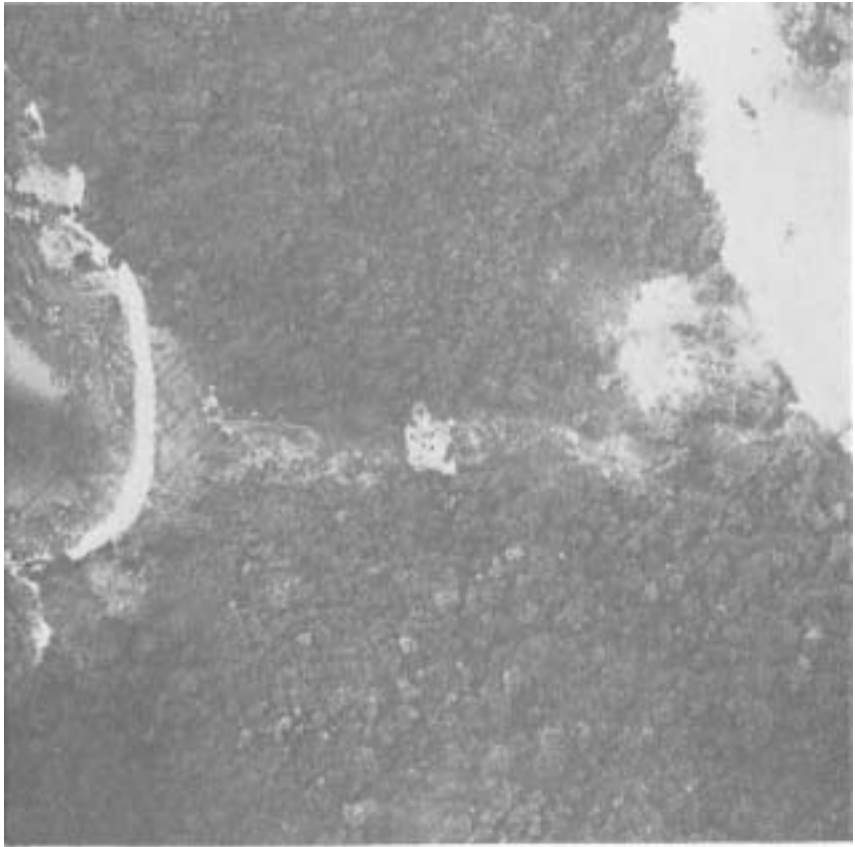

Marine forward elements from the western beach (at left) penetrated across the island neck as far as the clearing near the center of the photograph.

confirm their friendly status; they were the forward marine listening posts and were situated in a clearing almost halfway across the neck (see photo).

As the FAC prepared to coordinate strikes against enemy positions in and near the encampment area, the friendlies at the treeline reported they were taking small arms fire from north of their position. It was painfully evident that Cambodian forces still surrounded the contingent of marines and Air Force crewmembers—with darkness only two hours away, time was running out. Lt Backlund and his crew had now been orbiting off the island literally for hours and had witnessed repeated, futile attempts to suppress enemy fire and recover the friendly contingent on the eastern beach. They were still waiting for their chance to spearhead a rescue effort. Alarmed by the fact that daylight was nearly gone and disabused by the frustrating delays, Backlund radioed the FAC



USAF personnel hurriedly refuel a helicopter for a return trip to Koh Tang.

and in no uncertain terms summed up the urgency of the situation. It was time, he insisted, to get the action going; to put in some heavy, well-placed ordnance and root out an enemy who had been thwarting recovery attempts all day. The sun would soon be setting and they seemed no closer to getting the men out now than they had been hours earlier. Maj Undorf knew from the hard tone of the conversation that it was just such a pilot and crew that would be needed in the upcoming attempt to extract the men from the eastern beach.

In the next few minutes F-4s rocketed, bombed, and strafed well-concealed enemy huts in the encampment and the surrounding area. Undorf then methodically worked the F-4s north to positions inland from the friendlies at the treeline. Next he brought in A-7s who again worked over the same area.

When Maj Undorf flew down to take a look at the bombed area he saw enemy bodies and drew no gunfire. He then began preparations for the rescue attempt. Lt Backlund's chopper (Jolly 11) was to go in to the beach for the recovery. Capt Wall's crew\* (Jolly 12) would follow to provide suppressive fire and to examine the wreckage of Knife 23 for a marine seen there in the morning. Lt Brim's crew (Knife 51), back from delivering wounded to the staging base and refueling (see photo), also prepared to provide suppressive fire.

---

\* Capt Barry Walls and his fresh crew replaced Capt Jacobs and his crew after they had delivered wounded to their staging base.

Black Velvet 1, a longboat from the USS Wilson, was to stand off from the beach to provide a backup rescue platform should one of the helicopters be shot down. It also served a secondary function, to draw and return fire (the boat was armed with two machine guns). The men on the beach were to mark their position with smoke to insure easy acquisition by the rescue helicopters, and A-7s were overhead to provide air cover. In the event of enemy fire the helicopters were instructed to pull back to allow further strikes, but everyone knew time was growing short. Dusk was already approaching.

## **The Third SAR on the Eastern Beach**

Lt Backlund made a low-level, high-speed run-in to the beach, saw the survivors pop their marking smoke, and swung the helicopter's tail around toward the beach. The tide was in so he placed the ramp on the rocks and sand while the front of the aircraft hovered over the water. Although all three helicopters raked the shoreline with minigun and submachine gun fire, Jolly took ground fire from all quadrants, some from less than 50 meters away. As soon as the rescue helicopter touched down, the marines began an orderly withdrawal from the treeline, stopping every few feet to fire their weapons. Then when they were exposed on the rocky beach, a new enemy position opened up near the very treeline they had just left. The group spun around and dropped to the ground for a moment but decided it was time to make a break despite the accurate fire. They continued their orderly withdrawal, helping to suppress the position with their rifle fire. Despite the cumulative effects of daylong airstrikes and the fact that three helicopters were spewing minigun fire up and down the length of the treeline, enemy resistance was almost fanatical. At one point Cambodian soldiers, seeing the marines escaping from their grasp, stormed the helicopter and attained handgrenade range. Just as one of them started to throw his grenade the whole group was cut down by minigun and rifle fire. The grenade fell short of the mark and exploded without damage to the aircraft.

During the rescue Capt Walls and Lt Brims, their crews raising a wall of minigun fire, made repeated passes up and down the beach. Maj Undorf, flying low overhead, made a half dozen quick strafing passes as he spotted Cambodian positions firing on the marines and helicopters. Black Velvet 1 also returned enemy fire from its vantage point in the water northeast of the recovery location. The boat was forced to cease fire, however, when its machine gun rounds began ricocheting off the rocks north of the recovery location.

As the marines reached the ramp each one first turned to empty his magazine into the treeline before running up the ramp into the aircraft. Maintaining

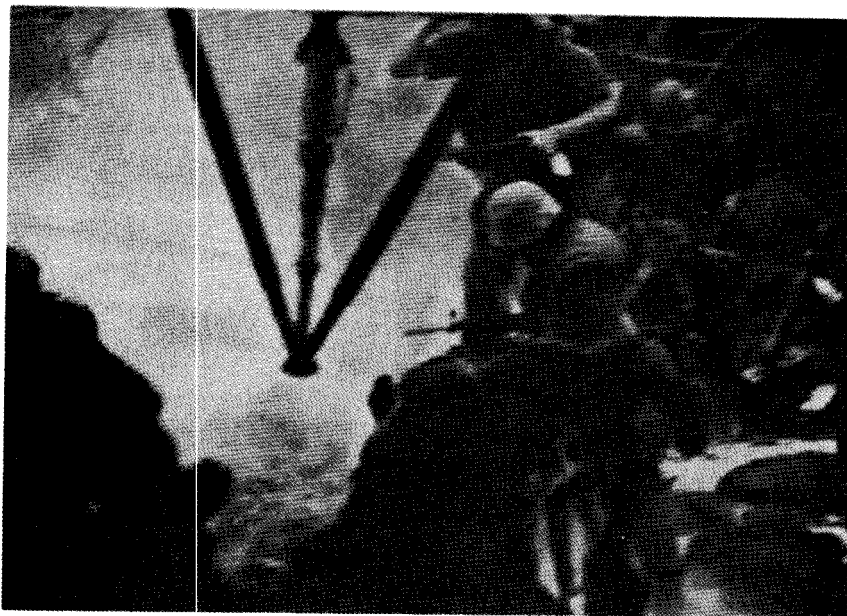

In the failing light, the 25 US Marines and USAF crewmembers trapped all day on the eastern beach are rescued. Jolly Green 11 hovers over the rocky beach with its nose above the water and its tail ramp down in the rocks and surf.

their chopper's position on the rocky beach (see photo) and helping the marines to board was a real team effort for the crew of Jolly 11. While several crewmembers manned the miniguns two pararescuemen went down the exposed ramp to expedite loading and to assist the wounded—they fired their rifles with one hand and forcefully assisted the marines on board with the other. A USAF photographer on Jolly 11 acted as a "floater," providing cover fire with his automatic rifle whenever it was most needed. Only when the crew was sure that all 25 marines and airmen were aboard did they signal Lt Backlund to pull out. Then as Jolly 11 departed the beach and began to pick up speed, a heavy-calibre machine gun opened up. The huge waterspouts from the weapon were clearly visible to Maj Undorf, and the line they made in the water allowed him to immediately locate the source. He rolled in and strafed the position, silencing it and allowing the safe withdrawal of the helicopters. Backlund reported on the radio that all 25 men were on board, but many of them were wounded. His crew tending to the injured, he raced to the USS Coral Sea, which at this time was 10 minutes away. Capt Walls and Lt Brims remained at Koh Tang to initiate a recovery attempt for the possible survivor seen earlier in the day on the Knife 23 wreckage.

It was approximately at this time that a USAF C-130 cargo aircraft lumbered over the island and delivered a huge 15,000 pound bomb. The blockbuster, dropped to apply maximum psychological pressure against Cambodian

soldiers resisting the withdrawal operations, blasted an area the size of a football field out of the dense jungle.

In the meantime Undorf was already marking targets for an AC-130 gunship which had just arrived on the scene. The Spectre then attacked the area surrounding the friendlies' former location at the treeline. After extensive softening by the gunship, an A-7 came in and delivered its bombs. Capt Walls and Lt Brims prepared to reenter the eastern beach so their crews could inspect the wreckage of Knife 23 for a possible survivor.

Walls flew Jolly 12 up to the wreckage and established a hover, immediately coming under heavy fire from the full length of the treeline up and down the beach. Brims hovered Knife 51 just to the south and his gunners cut loose with a barrage of minigun fire. With every bit of firepower sorely needed, the rest of the crew knocked out the side windows in the left rear of the aircraft and fired their rifles through the openings.

Despite the suppressive fire from both Knife 51 and Jolly 12, strong resistance continued. Although there was no sign of any survivor, Walls maintained a hover and his crew dropped their forest penetrator next to the downed helicopter as impacting enemy rounds banged against their aircraft. When the ramp minigun jammed, the crew returned fire from that position with their rifles.

The hoist operator, Sgt Jesus Dejesus, lowered the penetrator next to the crew entrance door of the downed chopper and dragged it back and forth through the water adjacent to the helicopter. (At this point the tide was in and the chopper was awash.) While doing this Dejesus was shot in the leg, but he simply ignored the wound. He continued to operate the hoist and remained in an exposed position with his head outside the aircraft, looking for any sign of a survivor.

Meanwhile the "waist" minigun on the left side of Knife 51 had run out of ammunition. Lt Brims quickly wheeled the chopper around to bring the right gun to bear on the shoreline. Those crewmen not manning miniguns promptly punched out the three right windows and again commenced firing their rifles. At that point Maj Undorf, flying low over the eastern beach in his OV-10, spotted a half-dozen helmeted figures rushing through the bushes toward the treeline to the right of where Brim's crew was directing fire. If they reached the beach they would be within hand grenade range of both helicopters. Undorf warned the crew of Knife 51 to adjust its fire to the right, and they cut down the enemy squad just as it approached the treeline.

After hovering over the downed helicopter for approximately 2 minutes and determining there was no survivor onboard, a severely damaged Jolly 12 began to withdraw, followed by Knife 51. Capt Walls recovered Jolly 12 on the Coral Sea. His aircraft had been hit hard; damaged components included its tail rotor section, hydraulic lines, auxiliary fuel tanks, and rotor blades. Lt Brims' aircraft, however, had apparently sustained no serious damage and so he remained at the island to pick up marines from the western beach. Two other helicopters, Jolly 43 (its ruptured fuel line repaired on the Coral Sea with a length of rubber hose and some tape) and Jolly 44 (just entering the

fray after being brought out of maintenance and repaired at its staging base), were also nearing the island. Thus only three SAR helicopters were available for the extraction of some 200 marines.

## **Extraction of Marines from the Western Beach**

Darkness had now fallen at Koh Tang. It has been suggested by some that American forces waited for night before withdrawing from the island. In fact the withdrawal had been delayed by the evacuation of the eastern beach, which was not finally completed until dusk was fading into night. With only the three remaining helicopters and with darkness hampering the acquisition of the landing zone and complicating any further SAR attempts should another helicopter be shot down, friendly forces had to decide whether or not to start withdrawal. The sobering chance that only part of the marines could be extracted and that a reduced, badly outnumbered force might then have to remain on the island throughout the night had to be considered. Yet the prospects of even the entire marine force remaining on the island overnight, with little hope of reinforcement or resupply, strongly militated for immediate withdrawal. Maj Undorf and Lt Col Austin frankly assessed the situation over the radio. Austin insisted that there had to be enough helicopters to get all of the marines out, or all would have to stay on the island through the night. It would take multiple sorties by each helicopter, but if further helicopter losses could be avoided it could be done. The decision was made to withdraw.

Lt Brims, his chopper low on fuel after participating in the recovery of the Knife 23 survivors, was the first into the western beach. Capt Purser (Jolly 43 pilot) and Lt Robert Blough (Jolly 44 pilot) held a short distance off the beach waiting for their turns to go in. Black Velvet 1 trolled offshore to provide suppressive fire to the north of friendly positions and, more importantly, to serve as a backup rescue capability should the need arise.

Enemy fire, including mortar-launched flares, greeted Brims and his crew in the landing zone. A firefight ensued between the marines, throwing up a curtain of fire, and Cambodian forces, who were firing into the landing zone at both the marines and the helicopter. Crewmembers added their minigun and rifle fire to the melee. As Knife 51 lifted off, loaded to capacity with marines, an enemy rocket streaked toward the aircraft but missed. With his crew already treating the wounded, Brims withdrew and made for the Coral Sea to offload and refuel.

As Capt Purser and Lt Blough reached the beach area, Undorf marked the enemy mortar position with smoke and called in tactical aircraft to strike the site. By that time, however, it was too dark for the fast-moving jets to acquire the marking smoke. Nevertheless, time was considered so critical that the extraction was continued rather than being delayed to coordinate strikes by a Spectre gunship or naval artillery. Purser maneuvered Jolly 43 onto the beach and began unloading more marines. Unruffled by the fact that only one of their miniguns was still operational, the crew aggressively returned fire with their



automatic rifles. The longboat from the Wilson was still providing suppressive fire. As for the marines, the firefight continued along the entire beach perimeter—muzzle flashes dotted the western side of the island neck.

In the darkness there was a near collision between Purser's chopper, on the beach, and Blough's aircraft, approaching the beach from behind with its landing lights shot out. Purser's copilot, Lt Gradle, quickly switched on the aircraft's spotlight just in time to allow Blough to see them. It was apparent that both helicopters could not fit into the landing zone at the same time. Blough pulled back and waited for Jolly 43 to depart. Purser poured on the power and Jolly 43 lifted out of the landing zone with 54 marines on board, more than double the normal combat loading configuration. Having taken numerous hits, including a 7.62mm round in the main rotor spar, the heavily laden Jolly 43 made for the Coral Sea to offload and ascertain battle damage.

As Lt Blough approached the beach in the darkness for a second time, accurate and heavy ground fire forced him to abort the evacuation attempt. Minutes later the marines had cleared the helicopter back in. Jolly 44 inched back toward the beach, the pilot guided through the darkness by instructions from crewmembers hanging outside the helicopter's door. Finally Blough touched down on the beach and the crew began to load the marines. The aircraft again started to receive small arms and automatic weapons fire but could not return it for fear of hitting friendly forces. While Jolly 44 was on the beach, however, the marines radioed that all their men were now within 50 meters of the landing zone. Maj Undorf began to strafe enemy positions with his OV-10, and Black Velvet 1 directed machine gun fire against hostile positions south of the beach. Blough, his helicopter fully loaded, withdrew from the landing zone.

With the departure of Jolly 44, some 73 marines were still on the western beach. The most crucial phase of the withdrawal was at hand; all three available helicopters were loaded and leaving the Koh Tang area, and the marine force on the island was under fire and badly outnumbered. Just at that critical point radio contact was lost with the remaining marines on the beach. Considering the urgency of the situation and disregarding the fact that his aircraft had just taken numerous hits, Blough decided to divert with his load of marines to the USS Holt, which was just off-shore at Koh Tang. This would save valuable time, eliminating the 20-minute round trip required to offload at the Coral Sea—but the helicopters which had delivered marines to the Holt in the morning had rated it a challenging task even with a normally loaded aircraft and under daylight conditions. How would the heavily loaded Jolly, in the darkness and with its landing lights out, negotiate a touchdown on a landing pad designed for much smaller helicopters?

Lt Blough made three passes at the landing pad but his landing lights were out and there was no lighting on the ship's superstructure next to the small pad. The red landing lights on the pad itself were his only visual points of reference. Further, the landing had to be made at an angle to avoid the protruding superstructure. Blough had to rely on directions received from one of his flight mechanics, SSgt Robert Bounds, who leaned out of the aircraft and judged the distance of the rotor tips from the ship's superstructure. As the helicopter

hovered above the pad with its tail and rear wheels hanging over the water, Blough slowly inched it forward until the main gear was just on the corner of the rectangular landing pad. The marines offloaded through the front door—they had to; the tail ramp was still sitting out over the water! As the helicopter departed, Lt Blough realized that the landing and the directions he had received from his flight mechanic must have been pretty good—there had been only a two-foot clearance between the rotor blades and the ship's superstructure. Blough rushed back to the landing zone to take on another group of marines.

While Jolly 44 had been at the Holt, Maj Undorf, running out of fuel and greatly concerned over the loss of radio contact with the marines, flew his OV-10 low over the beach with its landing lights on to verify that the Americans were still there and had not been overrun. This done, he and the other OV-10 Nail FAC departed the area as the two newly arriving Nails took over control of the evacuation operation. The Spectre gunship also confirmed the location of friendlies on its sensors before it departed and was replaced by a new Spectre. Within 10 minutes the new gunship had sighted its guns and was cleared to fire at targets as near as 50 meters from the beach.

Radio contact was finally reestablished with the ground commander, and he reported he was in danger of being overrun. Two minutes later he reemphasized the urgency of immediate evacuation, proclaiming it was time to "*go for broke.*" Continuous, accurate fire was laid down by the Spectre, and within 5 minutes Jolly 44 was back to the landing zone. In the total blackness, acquisition of the beach was helped by a blinking strobe light just set up by the marines. The copilot, 1/Lt Henry Mason, negotiated the difficult approach and touchdown, assisted by a marine on the ground who turned his flashlight on and off. While Jolly 44 was in the landing zone taking on marines, the Spectre gunship pounded enemy positions. One such position was the mortar site which had been active during previous extractions—it was silent during this recovery. Then as Jolly 44 lifted off with a full load, automatic weapons fire scored hits before being silenced by minigun fire. As the straining chopper began to pick up speed and altitude, one of the helicopter's two pararescuemen, Airman 1st Class David Ash, pulled in a marine who was dangling from the rear gun mount near the ramp. At the same time the other pararescueman began emergency treatment of four wounded marines. Jolly 44, losing power due to salt water ingestion in the engines, was forced to recover on the Coral Sea. Twenty-nine marines were still under fire on the western beach and there were no helicopters immediately available to make the pickup. Airpower would have to keep the enemy at bay until Knife 51 could return to the Island from the Coral Sea.

While the Spectre gunship shelled enemy positions surrounding the friendly perimeter, especially the area at the southern end of the beach, Lt Brims raced to Koh Tang with Knife 51. There was not even the hint of a moon, and by this time it was pitch black. As Brims approached in the darkness, the newly arrived low-FAC, Capt Seth Wilson, circled 1000 feet above the landing zone and switched his landing lights on and off to guide the helicopter in. Each time he did this he drew enemy fire, which the Spectre gunship then suppressed.

Brimms attempted three unsuccessful run-ins to the beach. Notwithstanding the use of the helicopter's running lights, the darkness, aggravated by smoke and haze from fires on the island, severely restricted visibility. Enemy ground fire and the deep water next to the beach at high tide further complicated the landing. On the fourth run-in the marines waved off the helicopter because they considered the beach unsafe, but Brimms pressed into the landing zone. While the wounded were being taken on, the rest of the marines set up suppressive fire, the Nail FAC delivered his rockets, the Spectre gunship laid down a continuous barrage, and Knife 51 added the firepower of its miniguns. The visual effects of the battle were like a scene from a science fiction movie: the bright tracers from the miniguns created a pulsing corridor of fire which surged from the helicopter and burned itself out in the jungle. In the face of this pommeling, enemy effectiveness was substantially diminished. Even so, some hostile fire was still being received, and sniper fire was observed coming from the beach itself. When 27 marines had boarded the helicopter, TSgt Wayne Fisk, ignoring the darkness and the hostile fire, left the safety of the aircraft and ran across the beach to the treeline to search for any marines who may have been left behind. At the treeline Fisk met with two marines still laying down suppressive fire. All three returned safely to the helicopter which then took off with the last 29 marines extracted from Koh Tang.

Minutes after the helicopter was out of the landing zone, enemy tracers from an antiaircraft artillery gun near the western beach lit up the sky. Then, when it became apparent there were no friendly forces in the vicinity of the western and eastern beaches, recovery operations were terminated. As US aircraft withdrew and began returning to their staging bases, a deathly stillness fell over Koh Tang. A fire in the levelled enemy encampment gave the eastern side of the island neck an unearthly glow, while on the western side of the neck all was dark save the intermittent blinking of the marine strobe light abandoned on the beach.

The delivery and subsequent withdrawal by helicopter of some 230 marines had been completed in the face of almost total uncertainty for planners and terribly unfavorable conditions for participating helicopters and marines. Yet the hazardous operation was undertaken unhesitatingly by all involved. It represented a chance for the recovery of the Mayaguez crew which could not be overlooked—and once the crew was recovered it became a life-and-death struggle to reinforce and subsequently withdraw those marines already committed to the operation on Koh Tang. Although damage was inflicted on all but one of the helicopters participating at Koh Tang, the efforts of USAF helicopter crews, with strong support from other Air Force and US Navy units, culminated in the extraction of the marine force from a situation which could otherwise have ended much less favorably.

Total US casualties during helicopter and ground operations at Koh Tang Island were 15 killed in action, 3 missing in action, and 50 wounded by hostile action. All 15 men killed were lost in the first 90 minutes of the operation. During the long day that followed, in the face of dangerously heavy resistance, the

reinforcement and withdrawal of marines was accomplished without further US fatalities. In addition, rapid helicopter evacuation of wounded saved other lives which might have been lost (see photos).



US casualties are rushed to waiting ambulances.



As Knife 51 touched down on the Coral Sea with the last load of marines from Koh Tang, a day of harsh challenges drew to a close. USAF FAC and strike aircraft headed back to their bases, while US marines on naval vessels and at their staging base relived their difficult day with both relief and a sense of satisfaction. After a grim start, the operation had ended on a positive note: the Mayaguez was steaming to port under the control of her crew, and some 230 marines had been recovered from the beaches at Koh Tang. The final outcome, however, had not been decided until the last minutes of the operation. At several points only three helicopters were left to recover the marines, and enemy resistance was still intense. A team effort by US forces at Koh Tang made the difference, yet the one sustaining element at the core of this effort was the persistence and determination of USAF helicopter crews—after 14 long hours at the beaches at Koh Tang, they finally prevailed.

## Appendix

### USAF Helicopter Crews Participating at Koh Tang

#### **Jolly Green 11**

1/Lt Backlund, Donald R.	Aircraft Commander
1/Lt Weikel, Gary L.	Copilot
SSgt Cash, Harry W.	Flight Mechanic
MSgt Eldridge, John J.	Pararescueman
Sgt Stanaland, Joseph S.	Pararescueman
A1C Marx, Brad E	Pararescueman
1/Lt Rand, Ronald T.	Cameraman

#### **Jolly Green 12(First Crew)**

Capt Jacobs, Paul L.	Aircraft Commander
Capt Nickerson, Martin A.	Copilot
SSgt Kaiser, Joseph L.	Flight Mechanic
MSgt Gray, David L.	Pararescueman
Sgt Cook, Burt W., Jr.	Pararescueman

#### **Jolly Green 12 (Second Crew)**

Capt Walls, Barry R.	Aircraft Commander
Lt Comer, Richard L.	Copilot
Sgt Dejesus, Jesus P. (Wounded in Action) (SSgt Cash, Harry H. replaced Dejesus)	Flight Mechanic
TSgt Patterson, David L.	Pararescueman
Sgt Styer, Randy H.	Pararescueman
A1C Rhinehart, Frederick	Pararescueman

#### **Jolly Green 13**

1/Lt Greer, Charles R.	Aircraft Commander
1/Lt Brown, Charles D.	Copilot
SSgt King, Milas L.	Flight Mechanic
SSgt Froehlich, Karl J.	Pararescueman
Sgt Lundrigan, Ronald A.	Pararescueman
Sgt Lemminn, Stephen W.	Pararescueman

#### **Jolly Green 41**

1/Lt Cooper, Thomas D.	Aircraft Commander
1/Lt Keith, David W.	Copilot
TSgt Little, Rhornell	Flight Mechanic
SSgt Donovan, Jeffrey	Flight Mechanic
SSgt Beranek, Thomas E.	Pararescueman
A1C Ferris, John E.	Pararescueman

**Jolly Green 42**

1/Lt Pacini, Philip M.  
 1/Lt Dube, Robert C.  
 TSgt Straughn, Andrew, Jr.  
 SSgt Jablonski, Martin M.  
 SSgt Brown, Michael A.  
 A1C Dunham, Lewis L., III  
 SSgt Cavazos, Martin

Aircraft Commander  
 Copilot  
 Flight Mechanic  
 Flight Mechanic  
 Pararescueman  
 Pararescueman  
 Cameraman

**Jolly Green 43**

Capt Purser, Roland W.  
 1/Lt Gradle, Robert P.  
 TSgt Willingham, Billy D.  
 TSgt Harding, Peter S.  
 Sgt Bateson, Thomas J. (Wounded in Action)  
 A1C McKiver, Dennis W.

Aircraft Commander  
 Copilot  
 Flight Mechanic  
 Pararescueman  
 Pararescueman  
 Pararescueman

**Jolly Green 44**

1/Lt Blough, Robert D.  
 1/Lt Mason, Henry M.  
 SSgt Bounds, Robert G.  
 SSgt Howell, Jimmy F.  
 Sgt Daly, Bruce M.  
 A1C Ash, David D.

Aircraft Commander  
 Copilot  
 Flight Mechanic  
 Flight Mechanic  
 Pararescueman  
 Pararescueman

**Knife 21**

Lt Col Denham, John H.  
 1/Lt Poulsen, Karl W.  
 TSgt Boissonnault, Robert A.  
 SSgt Rumbaugh, Elwood E. (Killed in Action)

Aircraft Commander  
 Copilot  
 Flight Mechanic  
 Flight Mechanic

**Knife 22**

Capt Ohlemeier, Terry D.  
 2/Lt Greer, David W.  
 SSgt Wilson, Michael C.  
 Sgt Paul, Norman A.

Aircraft Commander  
 Copilot  
 Flight Mechanic  
 Flight Mechanic

**Knife 23**

1/Lt Schramm, John H.  
 1/Lt Lucas, John P.  
 SSgt Gross, Ronald A. (Wounded in Action)  
 A1C Arrieta, Eduardo E.  
 SSgt Barschow, James M.

Aircraft Commander  
 Copilot  
 Flight Mechanic  
 Flight Mechanic  
 Cameraman

**Knife 31**

Maj Corson, Howard A., Jr. (Wounded in Action)  
 2/Lt Vandeger, Richard (Killed in Action)  
 SSgt Harston, Jon D. (Wounded in Action)  
 Sgt Hoffmaster, Randy L.

Aircraft Commander  
 Copilot  
 Flight Mechanic  
 Flight Mechanic

**Knife 32**

1/Lt Lackey, Michael B.  
 2/Lt Wachs, Calvin O.

Aircraft Commander  
 Copilot

TSgt Olsen, Michael B.  
SSgt Morales, Nick (Wounded in Action)

**Knife 51**

1/Lt Brims, Richard C.  
2/Lt Danielson, Dennis L.  
SSgt Riley, Marion L.  
A1C Pack, Phillip A.  
TSgt Fisk, Wayne L.  
Sgt Cooper, Ronald A., Jr.

**Knife 52**

1/Lt Rakitis, Robert E.  
2/Lt Lykens, David J.  
SSgt McDowell, Donald R.  
TSgt Dunbar, William R.

Flight Mechanic  
Flight Mechanic

Aircraft Commander  
Copilot  
Flight Mechanic  
Flight Mechanic  
Pararescueman  
Pararescueman

Aircraft Commander  
Copilot  
Flight Mechanic  
Flight Mechanic



## Glossary

A-7	A single-engine, all-weather, light attack aircraft
AC-130	A C-130 cargo aircraft modified with sensor equipment and armament making it suitable in the surveillance and attack role
Black Velvet 1	Call sign for a longboat from the USS Wilson
C-130	A four-engine, turbo-prop, medium-range cargo aircraft
C-141	A four-engine, turbo-fan, cargo aircraft with inter-continental range
Call Sign	Identifying words assigned to an aircraft, ship, unit, facility, etc., for the purpose of radio communications
Capt	Captain
F-4	A twin-engine, all-weather, tactical fighter aircraft
F-111	A twin-engine, all-weather, tactical fighter aircraft
FAC	Forward Air Controller—An officer who, from a forward ground or airborne position, controls aircraft engaged in close air support of ground troops
HC-130P	A C-130 cargo aircraft modified for inflight refueling of helicopters
Jolly Green	Call sign for HH-53 rescue helicopters
Knife	Call sign for CH-53 special operations helicopters
Lt	Lieutenant
Lt Col	Lieutenant Colonel
Maj	Major
mm	Millimeter
Nail	Call sign for OV-10 FAC aircraft
OV-10	A twin-engine, turbo-prop, light observation aircraft
P-3	Designation for the "Orion": A four-engine, turbo-prop, all-weather, long-range antisubmarine aircraft
PACAF	Pacific Air Forces
SAR	Search and Recovery
Sgt	Sergeant
SS	Steamship
SSgt	Staff Sergeant
Spectre	Call sign for AC-130 gunship
USAF	United States Air Force
USN	United States Navy
USS	United States Ship

**INDEX**  
for  
**THE VIETNAMESE AIR FORCE, 1951-1975,**  
**AN ANALYSIS OF ITS ROLE IN COMBAT**

AAA, 16-17, 30, 37, 39-41, 45-56, 49, 51-52, 54, 65, 81

ABCCC, 47, 51, 54

Aircraft—

A-1, 2, 19-20, 31, 34, 42, 45, 61

A-4, 22, 46

A-6, 46

A-7, 50, 54

A-37, 42, 46, 52, 55, 58, 63, 67, 71, 76-77

AC-47, 31

AC-119, 62

AC-130, 39, 47, 58

B-26, 5, 7

B-52, 21, 25-26, 30, 40, 49-50

C-7, 22

C-47, 2, 22

C-123, 22, 49

C-130, 22, 30, 33, 49, 61, 63, 71, 75, 78

C-141, 24

F-4, 19-20, 46, 54, 67

F-5, 55, 58, 63, 77, 79

F-8, 2, 46

F-100, 19-20, 31

F-105, 19-20

F-111, 50

H-34, 3

L-19, 2

MIG-21, 43

O-1, 12-13

O-2, 12, 14

OV-10, 12, 15

RF-5, 65

T-28, 2, 5-6

aircraft carrier, 41, 50

Air Component Commander (ACC), 4

Air Ground Operations System, 8-9

air liaison officer (ALO), 10-11, 60

airlift, 18, 22, 34, 40, 43, 51, 65

airmobile operations, 40

Air Operations Center (AOC), 8, 10

Air Police

Air Support Operations Center (ASOC), 10

An Loc, 46-47, 49-51, 53

ARDF, 11

Army, U.S., 4-5, 11, 31, 54, 65  
ARVN, 2, 5, 8, 10-12, 16, 18, 30, 39, 40, 46-47, 50, 59-60, 62, 69, 74  
Ban Me Thout, 73-74  
Bien Hoa AB, 5, 31, 71, 77  
bombing halt, 36, 53  
Cambodia, 39, 51  
Cam Ranh Bay AB, 74  
ceasefire, 53, 55, 57, 59  
centralized control, xiii, 5, 25, 29, 33, 43, 51, 69, 81  
China, 16  
close air support (CAS), 12, 31, 40  
command and control, 4-5, 76  
Combat Reporting Center (CRC), 8, 75-77  
Combat Reporting Post (CRP), 8, 77  
COMUSMACV, 22, 25, 43  
Congress, U.S., 57, 59  
Con Thien, 29, 40  
counter-insurgency  
Cooper-Church Amendment, xii, 57, 71, 82  
Corps, 4-5  
Dak To, 47  
Danang AB, 59, 70, 74-77  
Dien Bien Phu, 1, 29  
Direct Air Support Center (DASC), 10  
doctrine, 4, 10  
Easter offensive, xii, xiv, 36, 40, 51, 53, 63-65, 67  
Eglin Field, 4  
electronic countermeasures (ECM), 54, 63  
FARMGATE, 8, 10-11  
Forward Air Controller (FAC), 11-12, 24, 33, 45, 47, 49, 51, 60, 65, 67, 71, 77, 81  
French Air Force, 1  
guerrilla warfare, 1  
Haiphong, 16, 51, 53  
Hanoi, 16, 51  
heliborne operations, 11  
helicopters, 4, 10, 22, 65  
Hue, 30, 33, 40, 62, 70, 74  
infiltration, 38  
Invasion (1975), xii, xiv, 60, 63, 65, 67-68, 73  
insurgency, 1  
interdiction, xiii, 34, 38-39, 51  
Johnson, Lyndon B., 36  
Joint General Staff, 9-10  
Joint Operations Center (JOC), 10  
JUNGLE JIM, 4-5  
Kennedy, John F., 4  
Khanh, Gen. Nguyen Duc, 75-76  
Kontum, 46, 51, 62, 73-74  
Khrushchev, Nikita, 4  
LAMSON 719, 40, 45, 65  
Lanh, Gen., 76  
Laos, 34, 38-40, 54, 57  
lines of communication (LOC), 16  
logistics, xii, 16  
LORAN, 47

Marines, U.S., 21  
Military Assistance Command Vietnam (MACV), 21  
Military Assistance Program (MAP), 1  
Minh, Gen., 75  
Monkey Mountain, 76  
Mu Gia Pass, 42  
Navy, U.S., 22, 50  
negotiation, xii  
Nha Trang, 74  
Nixon, Richard M., 50  
North Vietnamese—  
    Air Force, 16  
    Army, 16–18  
operational control, 21, 25  
organizations—  
    1st Air Division (VNAF), 74–76  
    1st Division (ARVN), 41, 46, 52, 76  
    1st Marine Division, 21  
    2nd Division (ARVN), 76  
    3rd Division (ARVN), 46  
    3rd Marine Division, 21, 75  
    6th Air Division (VNAF), 74–75  
    7th Air Force, 19, 21  
    23rd Air Division (ARVN), 41, 73  
    4400th CCTS (U.S.)  
Parrot's Beak, 62  
peace agreement (Jan 1973)  
PEACOCK, 75  
Phan Rang AB, 75, 77–78  
Phu, Gen., 75  
Phu Cat AB, 75, 77  
Pleiku, 51, 54, 62, 73–76  
protective reaction strikes, 38  
Quang Tri, 29, 40, 45–47, 51, 53, 74  
Qui Nhon, 47, 59, 71, 73, 75  
reconnaissance, 34, 51  
Regional and Popular Force, 2  
restrictions, 16  
Saigon, 5, 31, 73, 75  
SAM, 16, 39, 41, 51–52, 54, 58, 62, 65  
    SA–2, 37, 62  
    SA–7, 37, 45–47, 49, 58, 62, 65, 67, 71  
sanctuaries, 53, 63  
Sang, Gen. Phan Ngoc, 74–75  
Special Forces (U.S. Army), 4  
Tactical Air Control Center (TACC), 8, 11, 43, 68, 77  
Tactical Air Control System (TACS), 4, 8, 24–26, 33, 51, 63  
Tactical Air Support Element (TASE), 11  
Tactical Operations Center (TOC), 10, 68  
tanks, 16, 37, 45, 47, 71  
Tan Son Nhut AB, 31  
Task Force 77, 21  
Tchepone, 39–40  
TET (1968), xii, xiv, 9, 16, 21, 29, 33, 39, 41, 63  
Thieu, President, 55, 59, 68, 73, 75, 80

Truong, Lt Gen., 74-75

U.S.S.R., 16-17

Vien, Gen. Cao Van, 9

Viet Cong, 16-18, 46

vietnamization, 40

VNAF, xii, xiv, 1-2, 5, 8, 11, 34, 40, 42, 46, 54, 56, 59-60, 62-64, 67, 69, 73, 80

wars of liberation, 4, 47

Xuan Tuc, 79

**INDEX**  
**for**  
**FOURTEEN HOURS AT KOH TANG**

A-7 forward air controller/strike aircraft, 115, 120, 122, 123, 135, 138-139, 142-143  
Ash, A1C, 148  
Austin, Lt Col, 123, 133, 146  
Backlund, 1/Lt, 134-135, 137, 141-143  
Bateson, Sgt, 137  
Black Velvet I, 143, 146-147  
Blough, 1/Lt, 146-148  
Bounds, SSgt, 147  
Brimms, 1/Lt, 134, 143-146, 148-149  
C-130, 144  
C-141, 100  
Cooper, 1/Lt, 119-120, 123, 127-128, 131  
Corson, Maj, 111-112  
Dejesus, Sgt, 145  
Denham, Lt Col, 106-107, 109, 111  
F-4 strike aircraft, 123, 143  
F-111 aircraft, 95, 97  
Fisk, TSgt, 149  
Gradle, 1/Lt, 147  
Greer, 1/Lt, 120-121  
Gross, SSgt, 113  
Harston, SSgt, 111-112  
HC-130, 119, 134  
Hoffmaster, Sgt, 111  
Jacobs, Capt, 134, 142  
Jolly Green 11, 128, 134-135, 137, 142, 144  
Jolly Green 12, 128, 134, 137, 142, 145  
Jolly Green 13, 120, 122  
Jolly Green 41, 108, 119, 123, 127  
Jolly Green 42, 119  
Jolly Green 43, 119, 128, 134-135, 137, 145-147  
Jolly Green 44, 137, 145-148  
Knife 21, 106  
Knife 22, 106-107, 111  
Knife 23, 111-113, 142, 145-146  
Knife 31, 111-115

Knife 32, 108-109  
Knife 51, 130, 134, 137, 142, 145-146, 148-149  
Knife 52, 130, 134  
Lackey, 1/Lt, 108-109  
Lucas, 1/Lt, 113, 115  
Mason, 1/Lt, 143  
Morales, SSgt, 109-110  
"Nail" OV-10 forward air controller aircraft, 139-141, 148-149  
Ohlemeier, Capt, 106, 108, 111  
P-3 aircraft, 95  
Pacini, 1/Lt, 119  
Poulo Wai Islands, 95  
Purser, Capt, 134-135  
Rakitis, 1/Lt, 134  
Roehrkasse, Capt, 140  
Rumbaugh, SSgt, 107  
Shramm, 1/Lt, 111  
"Spectre" AC 130 gunship, 1, 95, 122-123, 125, 127, 145, 148-149  
Tonkin, 1/Lt, 113, 115  
USS Coral Sea, 132, 137, 145-148, 151  
USS Harold E. Hold, 100, 116-118, 131-132, 147-148  
USS Henry B. Wilson, 131, 139-140, 143, 147  
Undorf, Maj, 140, 142-148  
Vandegeer, 2/Lt, 111  
Walls, Capt, 142-145  
Weikel, 1/Lt, 137  
Willingham, TSgt, 137  
Wilson, SSgt, 148